

TSSC Universal Gateway

Part Number: 106417-01
Instruction Manual
March 3rd, 2021 Revision 16



Contents

1. Introduction	5
2. Setup	6
3. Wiring	12
4. Commissioning	24
5. Field Validating	34
6. Troubleshooting	36
7. ProtoNode Information	43

Appendix

A. TSBC Control Points	45
B. Apex with Panasonic (4109) Points	48
C. Concert Control Apex, Amp/Bfit, Arctic/FreeFlex (4716) Points	52
D. Address DIP Switch Settings	58

Application

The Universal Gateway (ProtoNode) provides monitoring, remote setpoint, firing rate and burner on/off control to the Energy Management Systems/ Building Automation System/ Building Management System (EMS). It supports the following controllers:

- Thermal Solutions Boiler Control (TSBC)
- Apex with Control & Panasonic Display (4109 software)
- Apex with Control & Panasonic Display (4716 software)
- Apex with Concert Control & Display (4716 software)
- Arctic/FreeFlex with Concert Control & Display (4716 software)
- Amp/Bfit with Concert Control & Display (4716 software)

There are two ProtoNode Options:

BACnet ProtoNode: Provides BACnet MS/TP, BACnet/IP, N2, Modbus TCP communications.

LonWorks ProtoNode: Provides Lonworks communication.

Intent

This document provides the necessary information to facilitate Gateway installation. This Instruction Manual includes practical, installation and setup detailed information. The intended users are contractors and factory support personnel.



**FPC-N34-0816
BACnet ProtoNode**



**FPC-N35-0817
Lonworks ProtoNode**

Revision Notes

Rev. 7	Manual was changed to include 4716 software. EMS Details. A new appendix was added to include this information.
Rev. 8	General Changes, by Cloonan
Rev. 9	Preliminary release
Rev. 10	Updated further for 4716 software. New ProtoNode software released. Added Quick setup guide.
Rev. 11	Updated further for 4716 software.
Rev. 12	Fixed titles of sections in the Appendix and clarified 4109 and 4716 software.

Legend





Application	Appearance
<p>Thermal Solutions Boiler Control (TSBC)</p> <p>TSBC Software.</p>	
<p>Apex with Control & Panasonic Display (Apex with Panasonic)</p> <p>May be 4109 or 4716 Software. To check software, hit the "i" button on home screen.</p>	
<p>Apex with Concert Control & Display (Apex with Concert)</p> <p>4716 Software.</p>	
<p>Arctic/FreeFlex & Amp/Bfit with Concert Control & Display</p> <p>4716 Software.</p>	

TABLE OF CONTENTS

1 Introduction	5
1.1 BTL Mark – BACnet Testing Laboratory	5
1.2 LonMark Certification	5
2 Setup	6
2.1 Boiler Setup	6
2.1.1 Settings for Apex Boilers with Panasonic Display	6
2.1.2 Settings for Apex, Amp/BFit, and Arctic/FreeFlex Boilers with Concert Display	6
2.1.3 Setting the Boiler Address of EVS and EVCA boilers with TSBC	6
2.2 ProtoNode Setup	7
2.2.1 Select EMS Protocol	7
2.2.2 Enable Auto-Discovery	8
2.2.3 BACnet MS/TP Single Node and Multiple Node: Set MAC Address	9
2.2.4 BACnet MS/TP Single Node and Multiple Node: Set Serial Baud Rate	10
2.2.5 BACnet IP and BACnet MS/TP Multiple Node: Setting the Device Instance	10
2.2.6 BACnet MS/TP Single Node: Setting the Device Instance	11
2.2.7 Metasys N2 & Modbus TCP/IP Setup	11
2.2.8 Commission the ProtoNode for Lonworks	11
2.2.9 BACnet IP & Modbus TCP: Set IP Address	11
3 Wiring	12
3.1 ProtoNode Overview	12
3.2 Wiring to the ProtoNode 6 Pin Connector	14
3.3 TSBC: Boiler to ProtoNode Wiring	15
3.4 TSBC: Network Wiring	16
3.5 Apex with Panasonic: Boiler to ProtoNode Wiring	17
3.6 Apex with Panasonic: Network Wiring	18
3.7 Apex with Concert Display: Boiler to ProtoNode Wiring	19
3.8 Apex with Concert Display: Network Wiring	20
3.9 Arctic/FreeFlex 1000 with Concert: Boiler to ProtoNode Wiring	21
3.10 Arctic/FreeFlex 1500 – 3000 & Amp/BFit with Concert: Network Wiring	22
3.11 ProtoNode BACnet Wiring	23
3.12 ProtoNode LonWorks Wiring	23
4 Commissioning	24
4.1 Commissioning Lonworks ProtoNode	32
4.1.1 Instructions to Upload XIF File From the ProtoNode LER Using FS GUI Web Server	32
4.2 Commissioning BACnet ProtoNode	Error! Bookmark not defined.
4.2.1 Connect the PC to the ProtoNode via the Ethernet port	Error! Bookmark not defined.
4.3 ProtoNode WebApp GUI	Error! Bookmark not defined.
4.4 Set ProtoNode IP Address	29
5 Field validating	34
5.1 Downloading Chipkin Automation’s CAS Explorer and Requesting an Activation Key	34
5.2 CAS BACnet Setup	35
5.2.1 CAS BACnet MS/TP Setup	35
5.2.2 CAS BACnet IP Setup	35
6 Troubleshooting	36
6.1 LED Diagnostics	36
6.2 “No Communication” Troubleshooting Trees	37
6.2.1 General Troubleshooting	37

6.2.2	<i>BACnet IP Troubleshooting</i>	37
6.2.3	<i>BACnet MS/TP Troubleshooting</i>	37
6.2.4	<i>Metasys N2 Troubleshooting</i>	38
6.2.5	<i>Lonworks troubleshooting</i>	38
6.3	Take Diagnostic Capture with FieldServer Utilities	38
7	ProtoNode Information	43
7.1	Specifications and Ordering Information	43
7.2	ProtoNode Detailed View	44
	TSBC Points list	45
	Apex with Panasonic (4109) Points List	48
	Concert Control or Apex with Panasonic (4716) Points List	52
	“A” Bank DIP Switch Settings	58

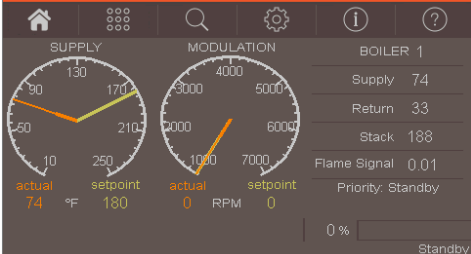
1 INTRODUCTION

Universal Gateway (ProtoNode) is an external, high performance Energy Management System (EMS) multi-protocol gateway that uses the **FieldServer ProtoNode Technology**. The ProtoNode can support multiple Boilers. It has been pre-programmed to Auto-Discover any Apex with Panasonic (4109 software), Apex, Arctic/FreeFlex, & Amp/BFit with Concert (4716 software), and Thermal Solutions Boiler Control (TSBC) equipped boilers connected to the ProtoNode and automatically configures them for BACnet¹MS/TP, BACnet/IP, Metasys² N2 by JCI, Modbus TCP or LonWorks³. It is not necessary to download any configuration files to support the required applications.

1.1 BTL Mark – BACnet Testing Laboratory



The BTL Mark on the Gateway is a symbol that indicates to a consumer that a product has passed a series of rigorous tests conducted by an independent laboratory which verifies that the product correctly implements the BACnet features claimed in the listing. The mark is a symbol of a high-quality BACnet product. Go to <http://www.bacnetinternational.net/btl/> for more information about the BACnet Testing Laboratory.

1.2 LonMark Certification



LonMark International is the recognized authority for certification, education, and promotion of interoperability standards for the benefit of manufacturers, integrators and end users. LonMark International has developed extensive product certification standards and tests to provide the integrator and user with confidence that products from multiple manufacturers utilizing LonMark devices work together.

¹ BACnet is a registered trademark of ASHRAE

² Metasys is a registered trademark of Johnson Controls Inc.

³ LonWorks is a registered trademark of Echelon Corporation

2 SETUP

Each ProtoNode has a unique part number located on the underside of the unit. This number should be recorded, as it may be required for technical support. The numbers are as follows:

Model	Part Number
ProtoNode RER - BACnet	FPC-N34-0816
ProtoNode LER - Lonworks	FPC-N35-0817

2.1 Boiler Setup

2.1.1 Settings for Apex Boilers with Panasonic Display

On Apex Boilers with **Panasonic GT02 display**, using the boiler mounted display, set a unique “Boiler Address” for each boiler that will be connected to the network.

- To change “Boiler Address” on Boiler Mounted Display; go to “Adjust” menu.
- In “Adjust” menu, enter “Sequencer Slave” menu to edit “Boiler Address”

**NOTE: For Apex Boilers with a Panasonic GT02 display;
All boilers must have Sequencer Master Disabled.**

2.1.2 Settings for Apex, Arctic/FreeFlex, & Amp/BFit Boilers with Concert Display

On Apex, Arctic/FreeFlex, or Amp/BFit Boilers with Concert Displays, assign a unique Comm HMI Station ID for each boiler connected directly to the ProtoNode.

- To change “Comm HMI Station ID” select “Menu” on Concert Display
- On the “Main Menu” select “EMS Interface” and select “Modbus Setup”
- Select “EMS Modbus Parameter” and follow on screen instructions to edit “Comm HMI Station ID”

2.1.3 Setting the Boiler Address of EVS and EVCA boilers with TSBC

On EVS and EVCA Boilers with TSBC, from the Communication Menu set the following:

Parameter	Selection
Protocol	Modbus
Modbus Address	Between 1 and 20
Baud Rate	38.4 kbps
Parity	None

- To edit Communication Parameters hold the “Menu” button down until the screen changes to the Main Menu of the TSBC
- Scroll through the main menu and select “COMMUNICATIONS” by pressing “Enter”.
- Edit Communication Parameters as needed.

Refer to the Boiler’s instruction manual for password and menu navigation instructions.

2.2 ProtoNode Setup

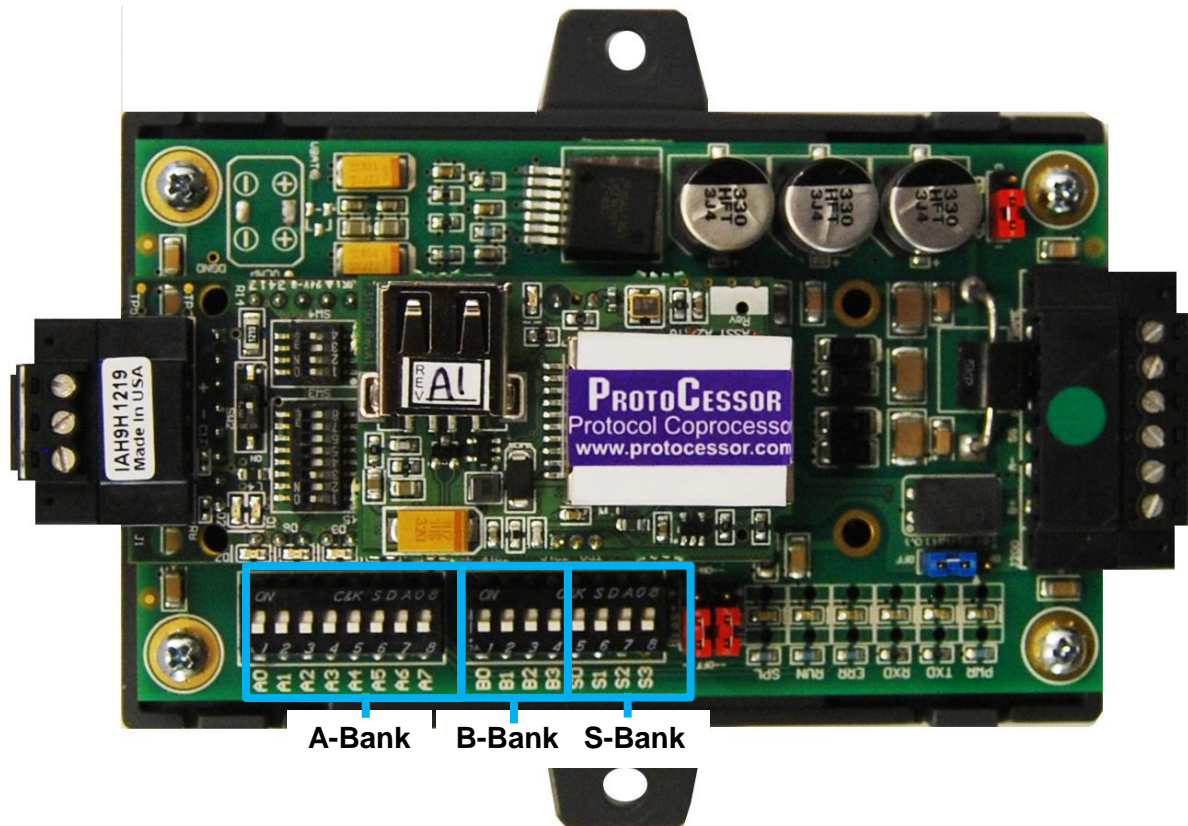

Figure 1: ProtoNode showing DIP switch “Banks” on bottom

2.2.1 Select EMS Protocol

Set Dipswitches to match Protocol of EMS. Remove ProtoNode cover and check protocol dip switch settings:

- The “S0 – S2” bank of DIP switches on the ProtoNode RER BACnet are used to select the various field protocols (BACnet MS/TP). See the chart below for the DIP switch settings.
- The “S0 – S2” bank of DIP switches on the ProtoNode LER LonWorks are disabled.
- “BACnet MS/TP (Multiple Node) is designed for MS/TP systems that are compatible with virtual nodes. The “Single Node” option is for MS/TP systems without this compatibility.

ProtoNode BACnet Profile	S Bank DIP Switches		
	S0	S1	S2
BACnet IP	Off	Off	Off
BACnet MS/TP (Multiple Node)	On	Off	Off
Metasys N2	Off	On	Off
Modbus TCP/IP	On	On	Off
BACnet MS/TP (Single Node)	Off	Off	On

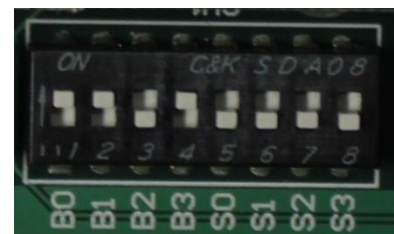

2.2.2 Enable Auto-Discovery

The following table describes “S3” DIP Switch setting for the Enabling Auto-Discovering of known devices attached to the ProtoNode RER or LER.

- Power down ProtoNode.
- Ensure all boilers are powered and connected to the ProtoNode.
- Set “S3” DIP switch to “On” position and power the ProtoNode to Auto-Discover Boilers. It will take 3 minutes to discover all Modbus RTU devices attached to the ProtoNode.
- Once the ProtoNode has discovered all of the Modbus RTU devices, set the S3 DIP switch to the OFF position to save the recently built configuration.

ProtoNode BACnet & Lonworks	
S3 DIP Switch Auto-Discovery Mode	S3
Auto-Discovery ON – Build New Configuration	On
Auto-Discover OFF – Load Current Configuration	Off

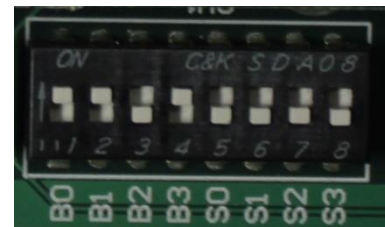

NOTE: Initial Auto Discovery Cycle

All boilers **MUST** be **POWERED** and **CONNECTED** to the ProtoNode before cycling power to the ProtoNode. The ProtoNode will auto discover only connected boilers. If a boiler is connected after the ProtoNode has completed auto discovery it will not “find” the new boiler.

2.2.3 BACnet MS/TP Single Node and Multiple Node: Set MAC Address

- Only 1 MAC address is set for ProtoNode regardless of how many devices are connected to ProtoNode.
- Set ProtoNode MAC Address. **(Must be between 1 and 127)**

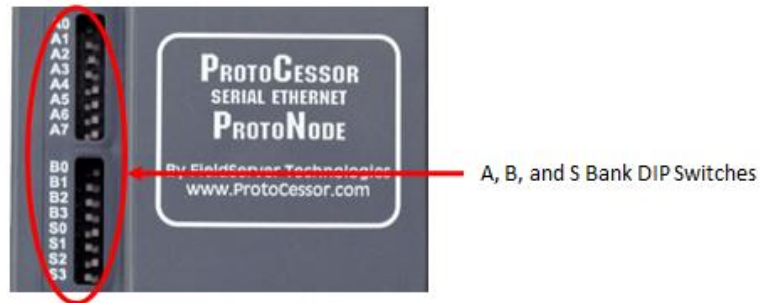

- Set DIP Switch (A0 – A7) for a MAC address between 1 and 127 which are Master addresses. (Appendix G shows settings)
- **Note: Never set a BACnet MS/TP MAC Address from 128 to 255.** Addresses between 128 and 255 are Slave address. BACnet Master Addresses pass tokens on the BACnet MS/TP network and can be Auto-Discovered by Energy Management System (EMS) front end systems that support Auto-Discovery. BACnet Slave Addresses cannot pass Tokens and will never be Auto-Discovered by EMS front end systems that support Auto-Discovery.

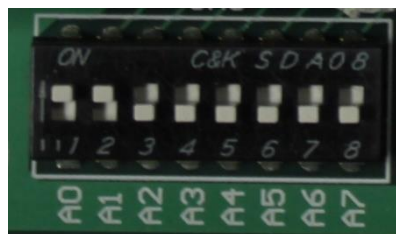

Figure 2: A0 – A7 DIP Switches (MAC address “3” is show)

- Please refer to Appendix D for the full range of addresses to set Node-ID/Device Instance.

NOTE: When setting A Bank DIP Switches, please ensure that power to the board is OFF.

2.2.4 BACnet MS/TP Single Node and Multiple Node: Set Serial Baud Rate

DIP Switches B0 – B3 are used to set the serial baud rate to match the baud rate provided by the Energy Management System.

Baud	B0	B1	B2	B3
9600	On	On	On	Off
19200	Off	Off	Off	On
38400	On	On	Off	On
57600	Off	Off	On	On
76800	On	Off	On	On

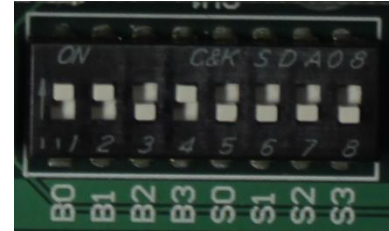

Figure 3: B0 – B3 DIP Switches (38400 Baud shown)

2.2.5 BACnet IP and BACnet MS/TP Multiple Node: Setting the Device Instance

The BACnet device instances will be set by the “Node Offset” + “Boiler Address” (Modbus RTU device).

The BACnet Device Instance can range from 1 to 4,194,303.

To assign specific Device Instance values, change the Node_Offset value.

- The Node_Offset value is currently set to 50000 in the configuration file
- Modbus address 1 would be assigned a device instance of 50001.
- Modbus address 2 would be assigned a device instance of 50002.
- Modbus address 3 would be assigned a device instance of 50003.

The device instance is calculated by: Device Instance = Node_Offset + Modbus Address

- The Node_Offset can be changed from 50000 to any number between 1 and 4,194,302 via the Web Configurator. (To use web configurator see section 4.3)

2.2.6 BACnet MS/TP Single Node: Setting the Device Instance

The BACnet single node instance will be set by the “Node Offset” + “MAC Address”. All registers from the devices connected to the ProtoNode will be listed under this single node instance. The registers are organized each devices “Modbus Address.”

To assign a specific single node instance value, change the Node_Offset or MAC address value.

- The Node_Offset value is currently set to 50000 in the configuration file
- MAC address 1 would be assigned a node instance of 50001.
- MAC address 2 would be assigned a node instance of 50002.

The Node_Offset can be changed from 50000 to any number between 1 and 4,194,302 via the Web Configurator. (To use web configurator see section 4.3)

Under this single node, the registers will be listed by their Modbus Address.

- Modbus address 1 will be listed sequentially as 1001, 1002, 1003...etc.
- Modbus address 2 will be listed sequentially as 2001, 2002, 2003...etc.

2.2.7 Metasys N2 & Modbus TCP/IP Setup

Metasys N2 & Modbus TCP/IP Device Address Setting

- The device addresses will be the same as the discovered Boilers’ Boiler Address (Modbus RTU devices) (1 through 8).

2.2.8 Commission the ProtoNode for Lonworks

This needs to be done by the LonWorks administrator use a LonWorks Commissioning tool. (See Section 4.7)

2.2.9 BACnet IP & Modbus TCP: Set IP Address

Run the ProtoNode web GUI utility program to change the IP address to match network. No changes to the configuration file are necessary. (See Section 4 for details on the Web Configurator)

3 WIRING

3.1 ProtoNode Overview

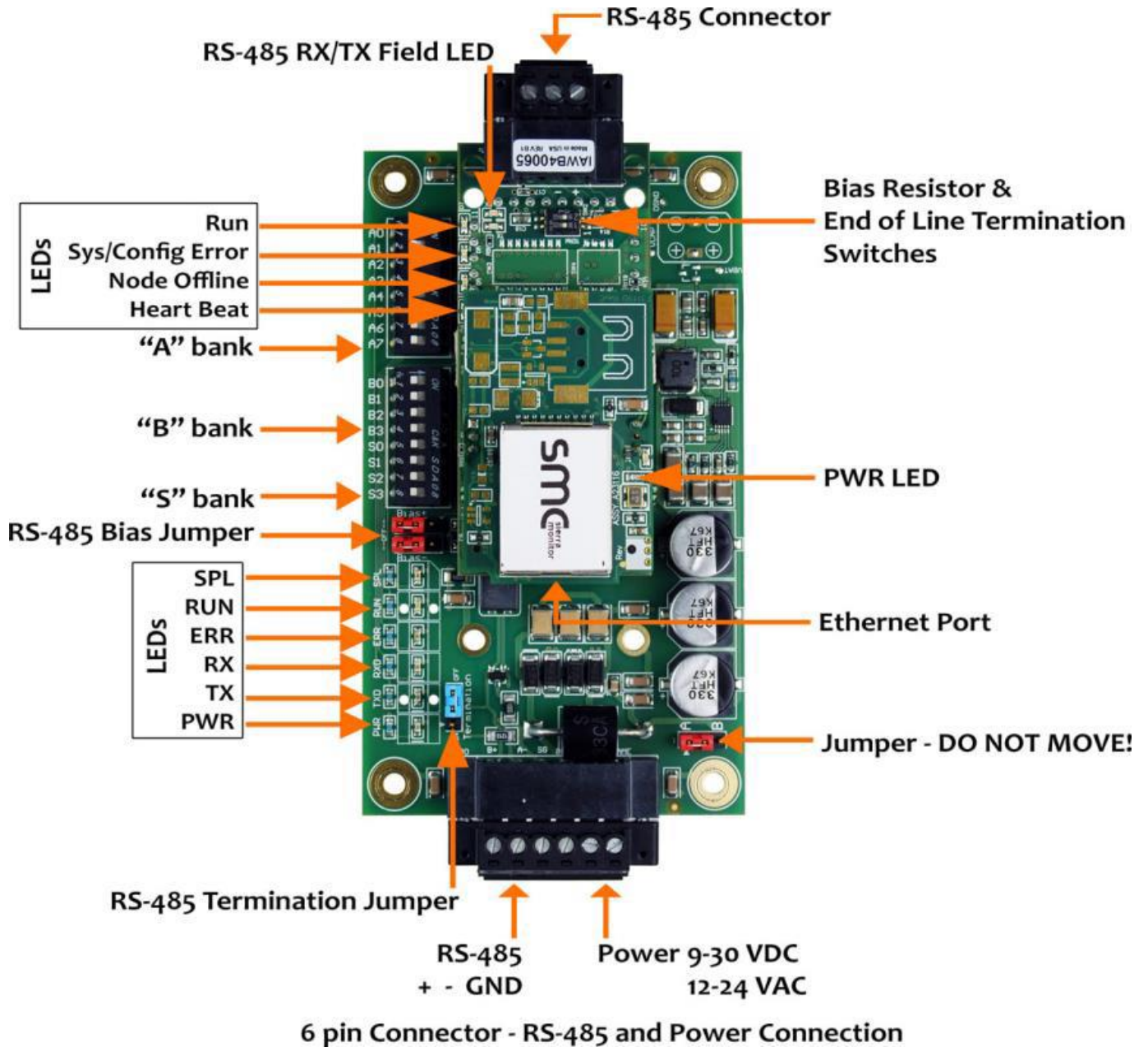

Figure 4: ProtoNode BACnet

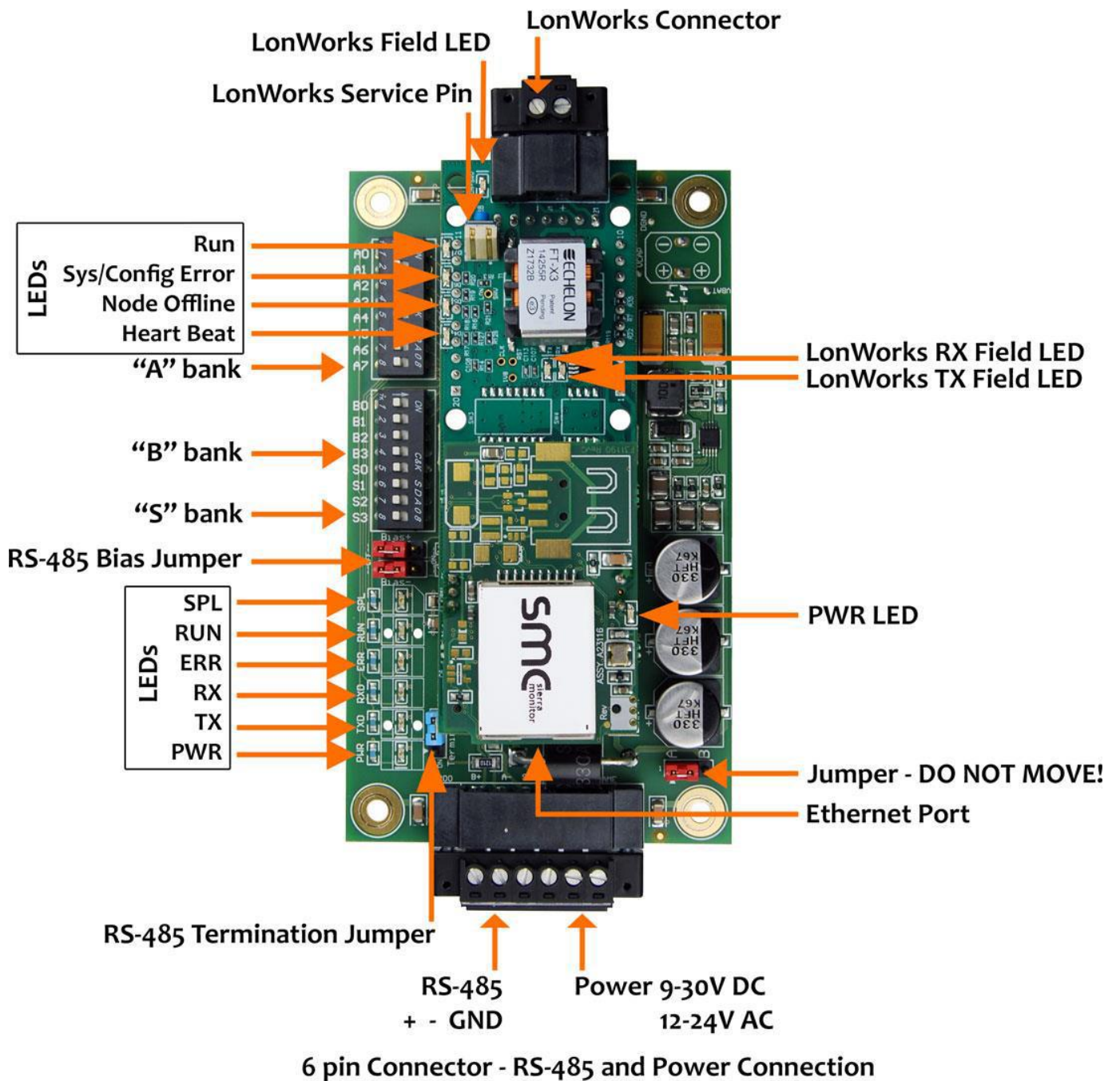
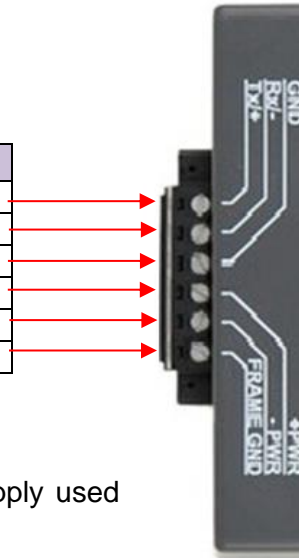

Figure 5: ProtoNode Lonworks

3.2 Wiring to the ProtoNode 6 Pin Connector

- The 6 pin connector is the same for ProtoNode BACnet and Lonwork
- Pins 1 through 3 are for Modbus RS-485 devices. The RS-485 GND (Pin 3) is not typically connected.
- Pins 4 through 6 are for power.

Device Pins	ProtoNode Pin #	Pin assignment
Pin RS-485 +	Pin 1	RS-485 +
Pin RS-485 -	Pin 2	RS-485 -
Pin GND	Pin 3	RS-485 GND
Power In (+)	Pin 4	24 VAC +
Power In (-)	Pin 5	24 VAC -
Frame Ground	Pin 6	FRAME GND



Apply power to ProtoNode as show below. Ensure that the power supply used complies with the specifications provided in Section 7.

- ProtoNode accepts either 9-30VDC or 12-24 VAC on pins 4 and 5.

Power Requirement for ProtoNode at 9V through 24 VAC	
	Current Draw Type
ProtoNode Family	24VAC
FPC – N34 – 0816 BACnet ProtoNode	140mA
FPC – N35 – 0817 Lonworks ProtoNode	130mA

3.3 TSBC: Boiler to ProtoNode Wiring

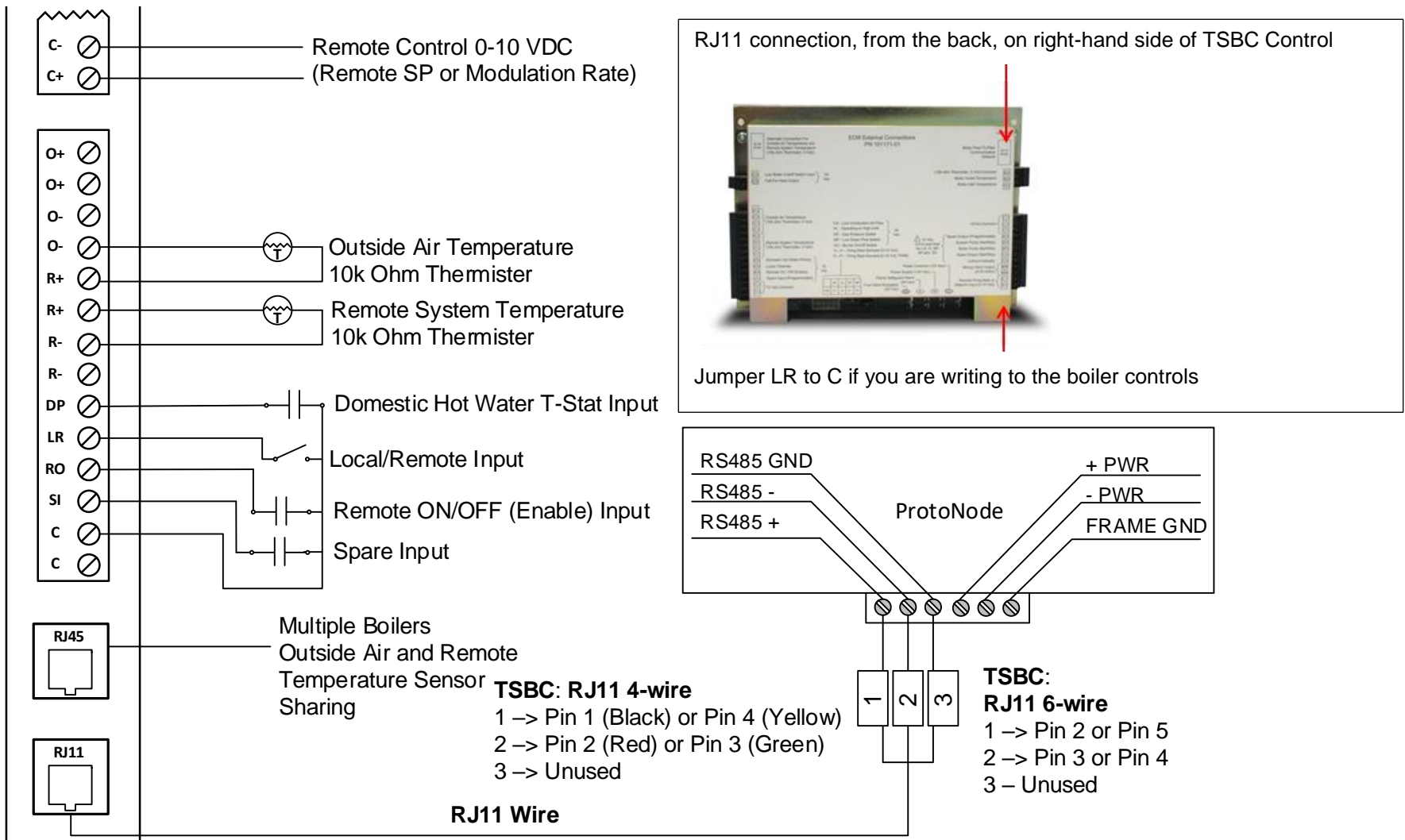

Wiring TSBC Modbus Communication to an Energy Management System (EMS)

The Modbus communication connects to the same RJ11 port that is used by the boiler to boiler communication. Connect one end of the RJ11 cable to the TSBC and cut off the other end of the cable to access the individual wires of the RJ11 cable. Wire the RJ11 cable as shown above.

3.4 TSBC: Network Wiring

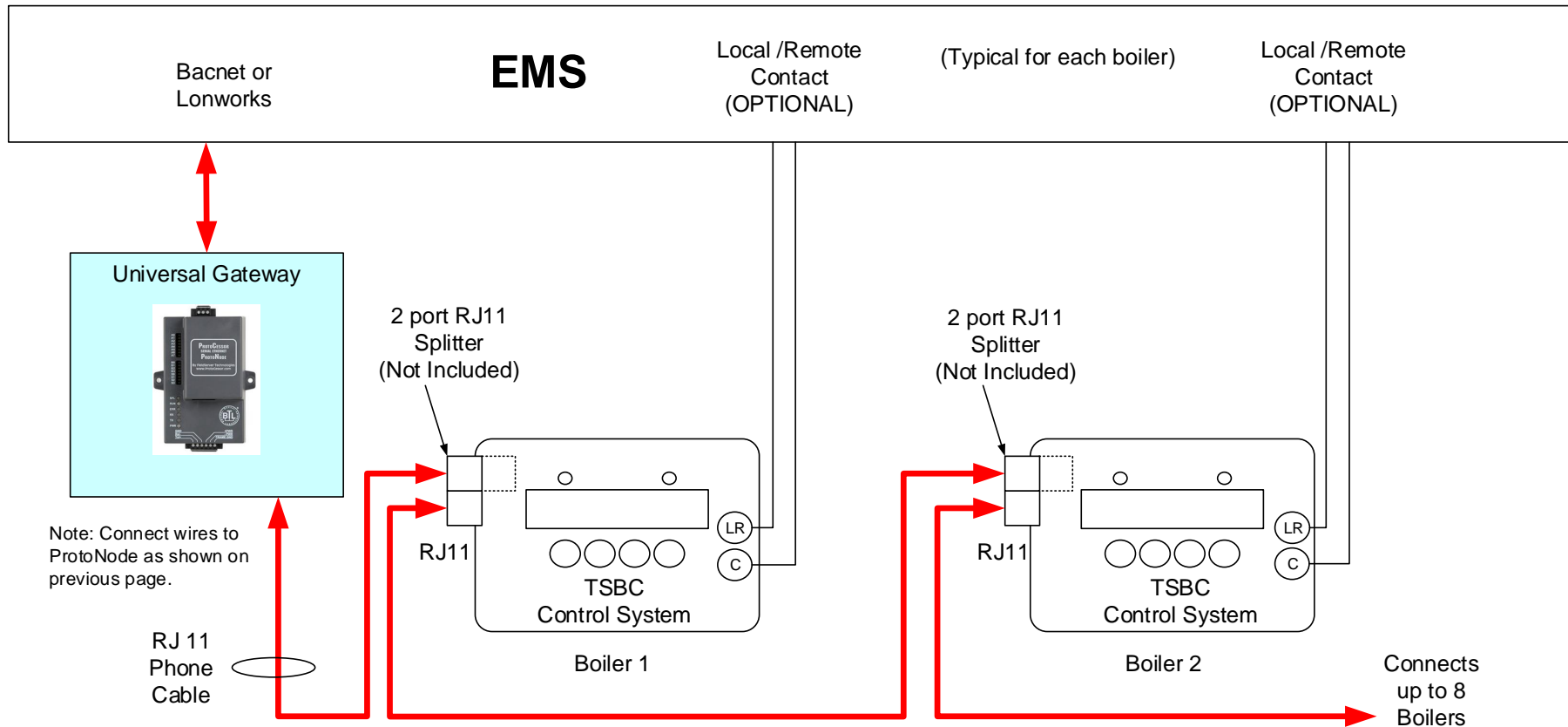

IMPORTANT NOTES for TSBC Connections:

1. When controlling Setpoint with the EMS, the user does not have access to Enable/Disable, and Lead Lag. User must do a contact closer to RO & C on each boiler. When controlling Modulation, user does have access to Enable/Disable, and Lead Lag.
2. When the EMS is connected, boiler sequencing (Multiple Boiler Lead/Lag) must be done external to the Boiler Control by other means.
3. Boiler Enable/Disable and Firing Rate are sent over the ProtoNode, or may be directly wired.

3.5 Apex with Panasonic: Boiler to ProtoNode Wiring

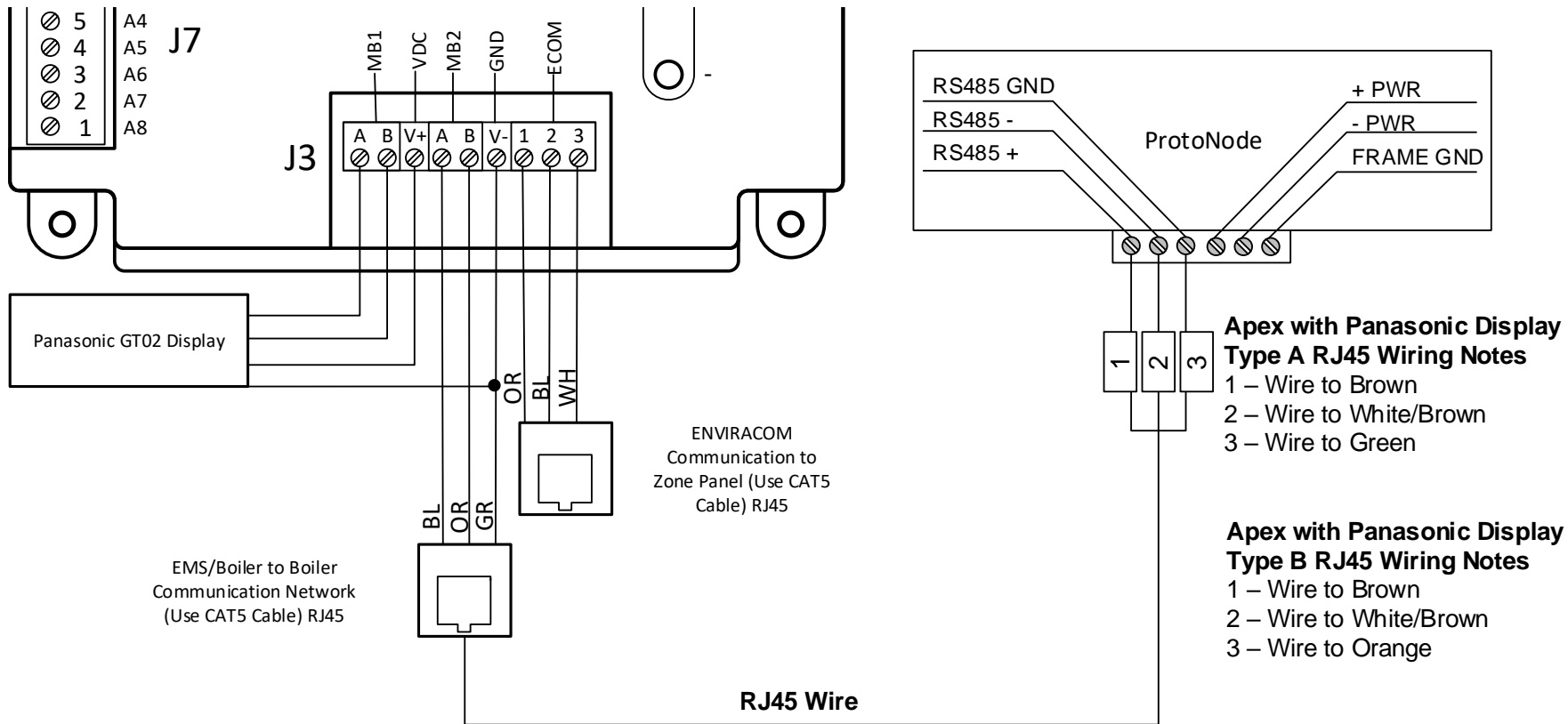

Wiring Apex with Panasonic Modbus Communication to an Energy Management System (EMS)

The Modbus communication connects to the same RJ45 port that is used by the boiler to boiler communication. Connect one end of the RJ45 cable to the boiler and cut off the other end of the cable to access the individual wires of the RJ45 cable. Wire the RJ45 cable as shown above.

3.6 Apex with Panasonic: Network Wiring

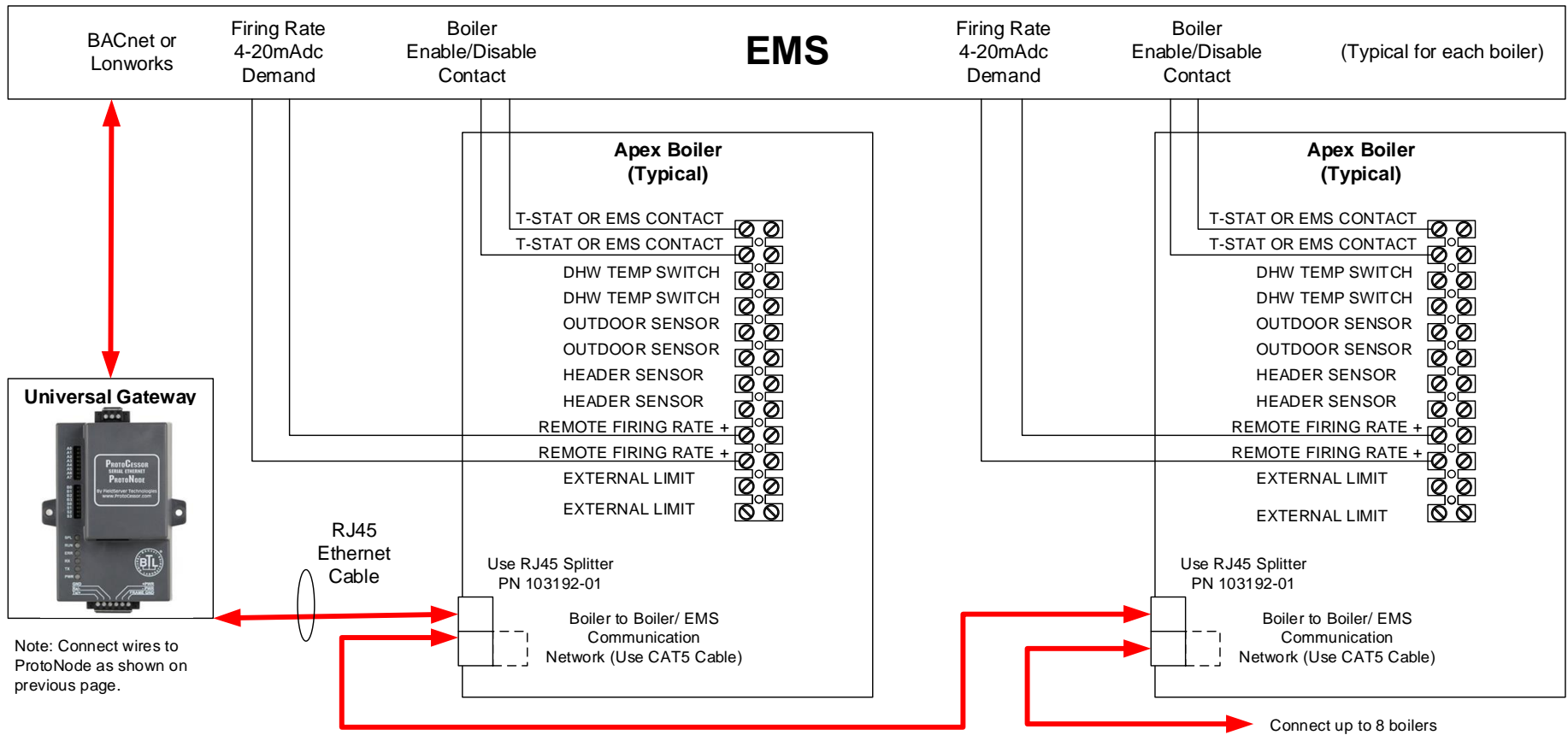

IMPORTANT NOTES for Apex with Panasonic display Connections:

1. When the Energy Management system is connected, boiler sequencing (multiple boiler lead/lag) must be done external to the boiler controls, by other means.
2. Both Enable/Disable and Remote Firing Rate must be wired to the boilers to provide boiler sequencing (multiple boiler lead/lag).
3. If only the burner on/off Modbus signal is used instead of the Enable / Disable contact input the boiler will be turned off but the system pump may remain running.
4. The Sequencer must be disabled while communicating with EMS (i.e. no Master Boilers).

3.7 Apex with Concert Display: Boiler to ProtoNode Wiring

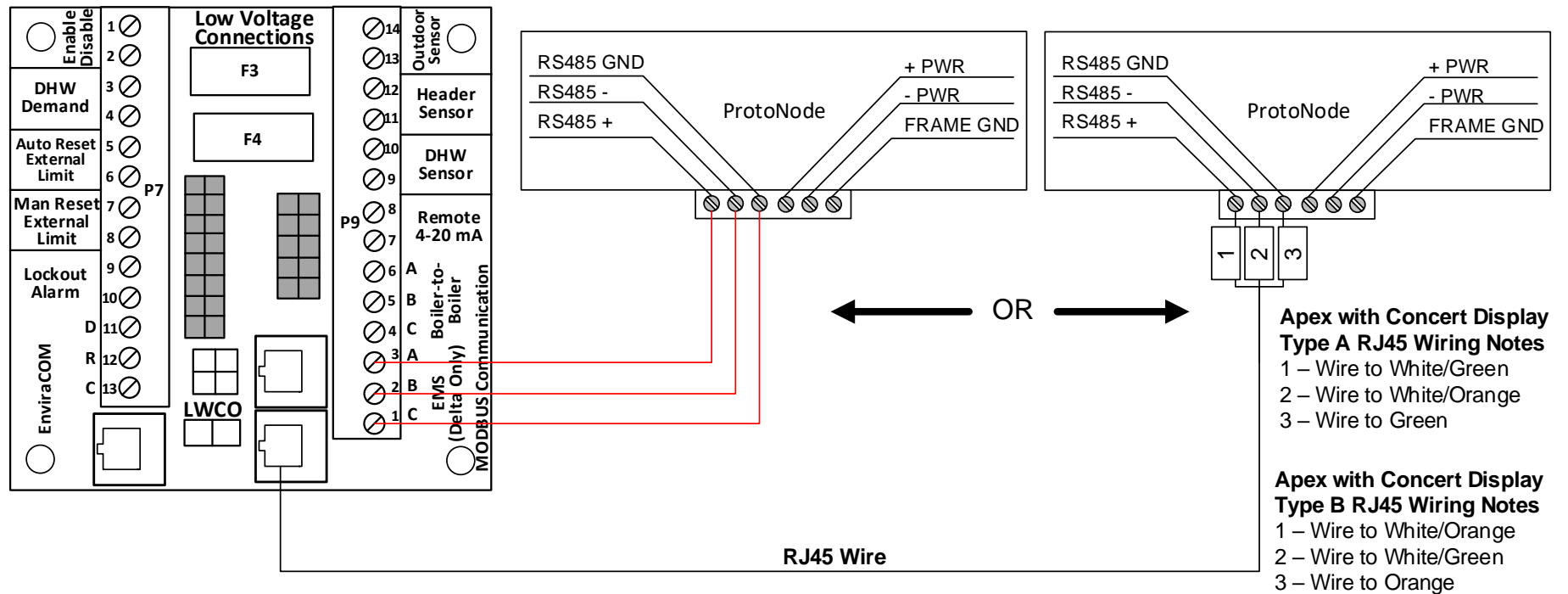

Wiring Apex with Concert Modbus Communication to an Energy Management System (EMS)

There are two options for wiring the ProtoNode to an Apex with Concert Display.

1. Connect one end of an RJ45 cable to the boiler PCB and cut off the other end of the cable to access the individual wires of the RJ45 cable. Wire the RJ45 cable as shown above.
2. Wire the ProtoNode to the PCB using the EMS (Delta Only) terminals.

3.8 Apex with Concert Display: Network Wiring

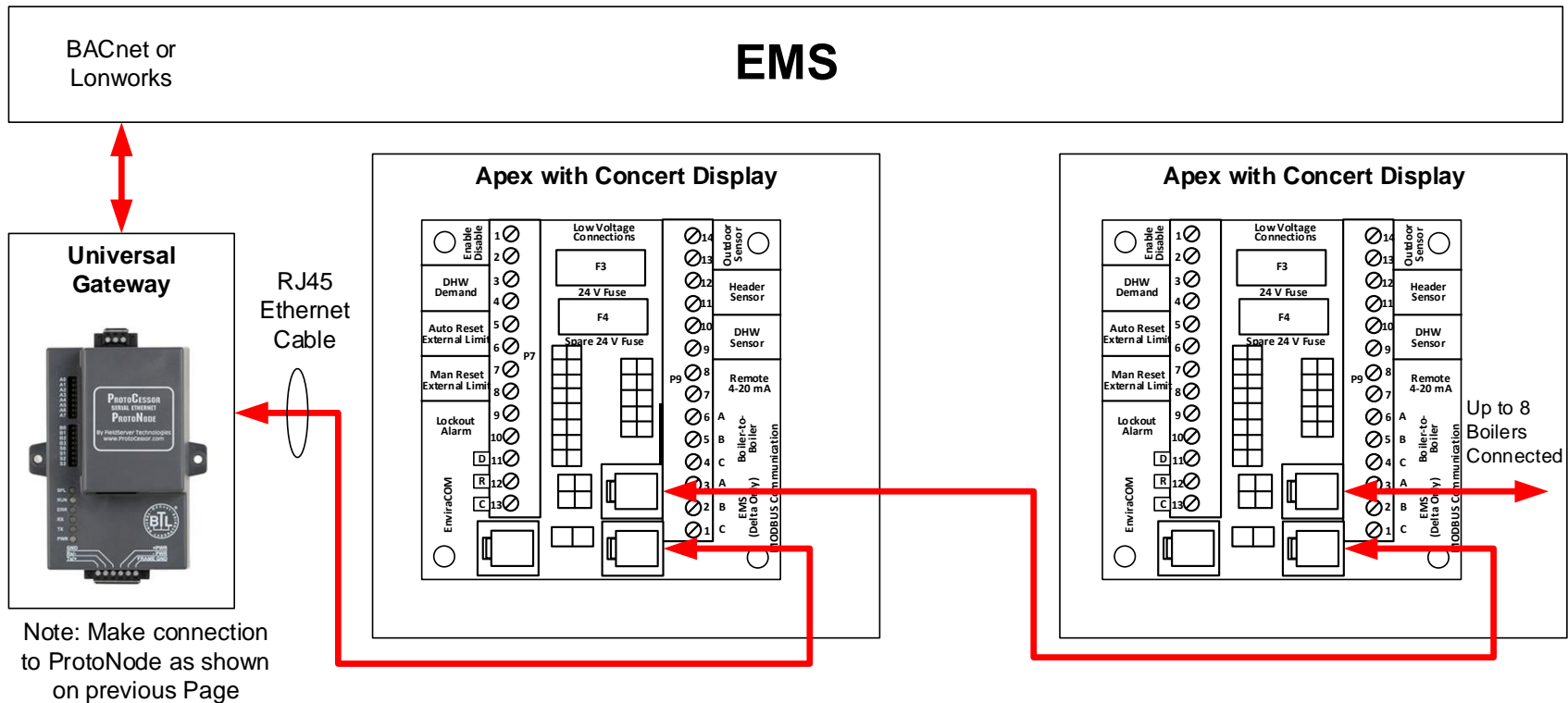

Note: Make connection to ProtoNode as shown on previous Page

IMPORTANT NOTES for Apex with Concert Display Connections:

1. All Apex with Concert Display are equipped with a PCB to easily establish communication with an EMS.
2. Apex with Concert Displays are able to do both Lead Lag (Sequencer) and EMS communication at the same time.

3.9 Arctic/FreeFlex 1000 with Concert: Boiler to ProtoNode Wiring

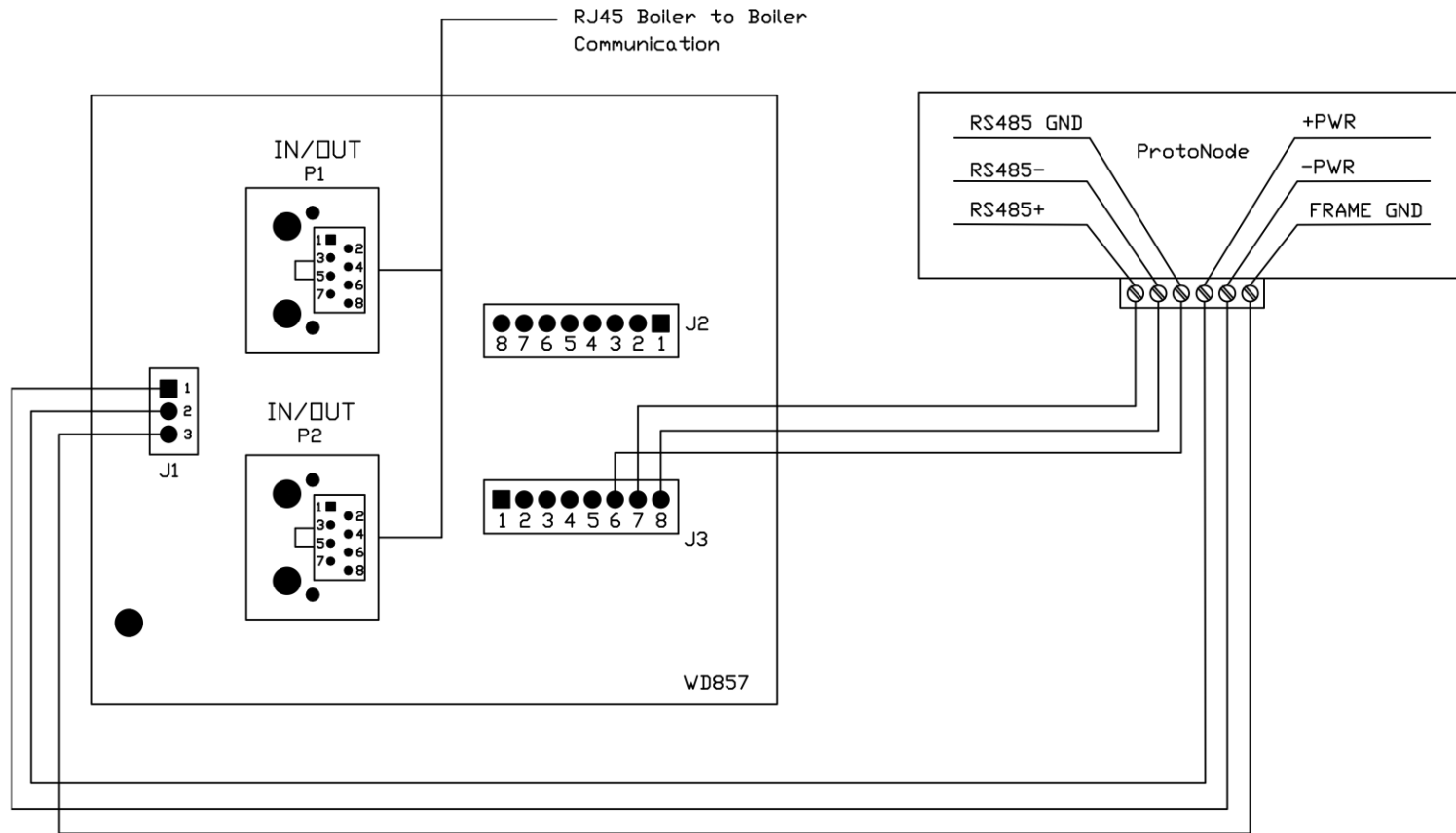

IMPORTANT NOTES:

1. Arctic/FreeFlex with Concert Display is able to do both Lead Lag (Sequencer) and EMS communication at the same time.
2. For Arctic/FreeFlex Boilers not equipped with PCBs refer to an earlier revision of this manual.
3. Older Arctic/FreeFlex 1500 – 3000 boilers equipped with this PCB may use this wiring.

3.10 Arctic/FreeFlex 1500 – 6000 & Amp/BFit with Concert: Network Wiring

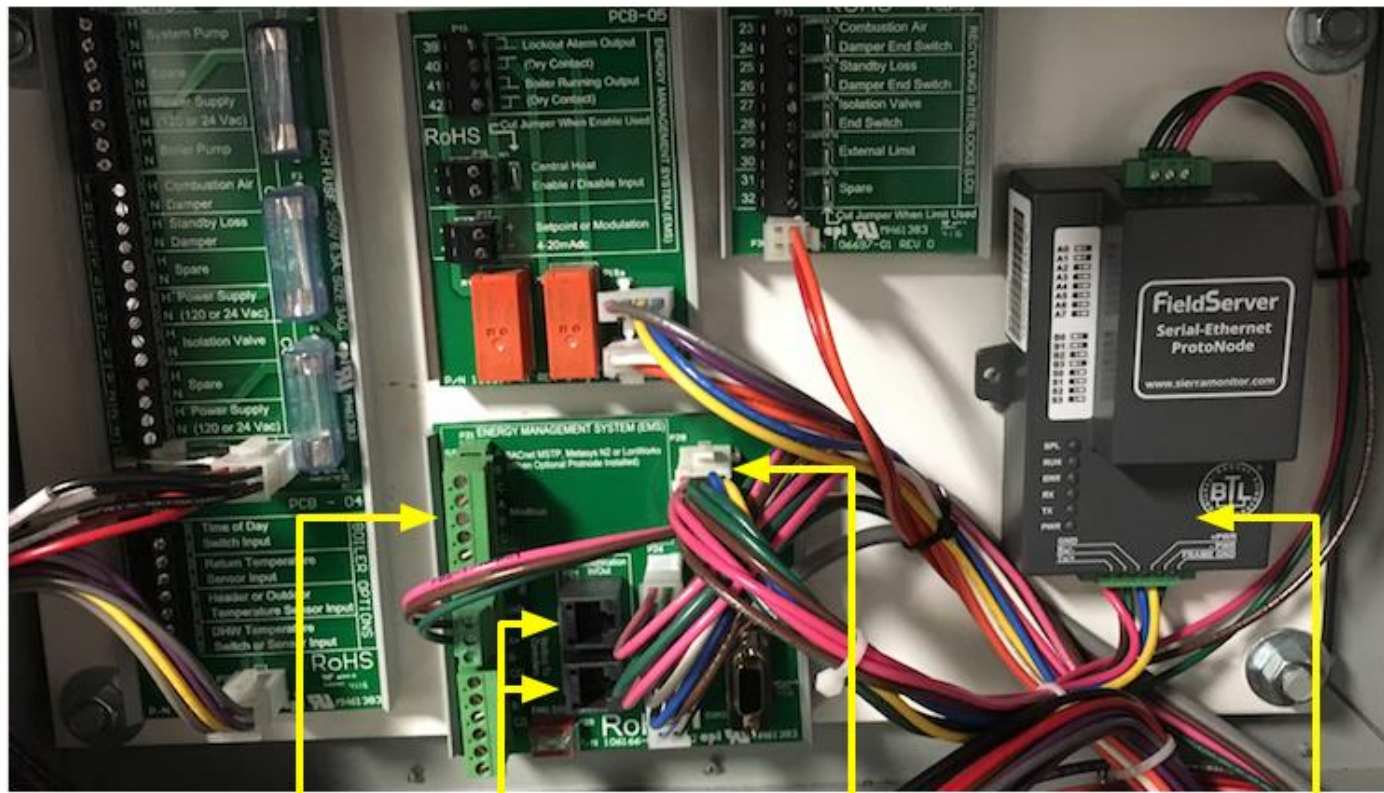

EMS BACnet MSTP, Metasys N2,
or Lonworks
55 - A+
56 - B-
57 - Cg

RJ45 Boiler to Boiler
Communication

Protonode wiring
harness (T20126.9
BACnet) (T20126.15
LonWorks0

Protonode

IMPORTANT NOTES:

1. Arctic/FreeFlex & Amp/BFit with Concert Displays are able to do both Lead Lag (Sequencer) and EMS communication at the same time.
2. For Arctic/FreeFlex Boilers not equipped with PCBs refer to an earlier revision of this manual.

3.11 ProtoNode BACnet Wiring

Wiring the BACnet ProtoNode to the Network (RS-485 Field Protocol)

- Connection from ProtoNode RER to **BACnet MS/TP**, and **Metasys N2** network.
- See Section 4.2 for information on connecting the BACnet ProtoNode to a **BACnet IP** network.
- The Field Protocol can be connected to the 3-pin connector on ProtoNode RER as shown.

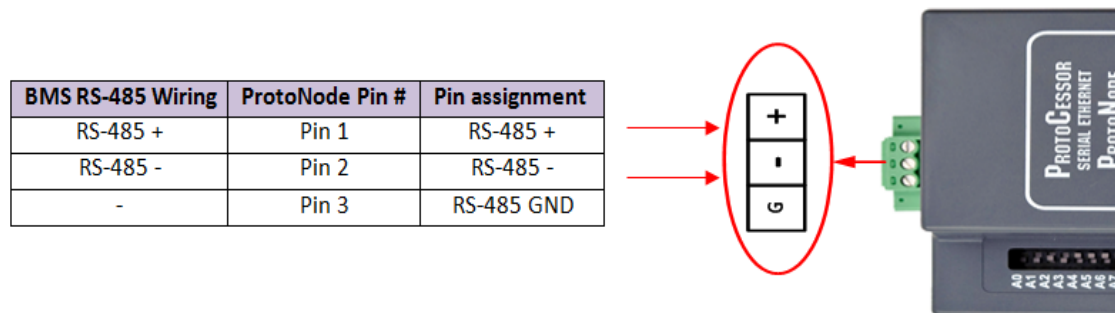

Figure 6: Connection from ProtoNode to RS-485 Field Protocol –BACnet MS/TP or Metasys N2.

- If the ProtoNode is the last device on the RS-485 trunk, then enable the End-of-line termination needs to be enabled. The default is off (switch position = right side).



Figure 7: End-of-line termination on from ProtoNode to RS-485 Field Protocol –BACnet MS/TP or Metasys N2.

3.12 ProtoNode LonWorks Wiring

- Connect the ProtoNode to the field network with the LonWorks terminal using a twisted pair non-shielded cable. LonWorks has no polarity.



4 COMMISSIONING

4.1 Use the ProtoNode Web Configurator to setup the Gateway

First, connect a standard CAT5 Ethernet cable (straight through or cross-over) between the local PC and ProtoNode.



Figure 9: Ethernet port location on the ProtoNode

There are two methods to access the ProtoNode via Ethernet connection, either by changing the subnet of the connected PC (Section 4.1.1) or using the FieldServer Toolbox to change the IP Address of the ProtoNode (Section 4.1.2).

4.1.1 Changing the Subnet of the Connected PC

The default IP Address of the ProtoNode is **192.168.1.24**, subnet mask is **255.255.255.0**. If the PC and the ProtoNode are on different IP Networks, assign a static IP Address to the PC on the 192.168.1.xxx network.

- For Windows 10:

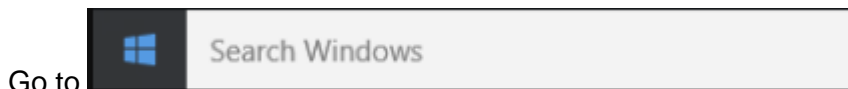

Type "control panel"

Then click Control Panel > Network and Internet

> Network and Sharing Center > [Change adapter settings](#)

Right-click on Local Area Connection > Properties

Highlight [Internet Protocol Version 4 \(TCP/IPv4\)](#) > [Properties](#)





- Select: Use the following IP address

Use the following IP address:

IP address:	192 . 168 . 1 . 11
Subnet mask:	255 . 255 . 255 . 0
Default gateway:	

- Click [OK](#) twice

- For Windows 7:

Go to  >  Control Panel >  Network and Internet
>  Network and Sharing Center > [Change adapter settings](#)

Right-click on Local Area Connection > Properties

Highlight  Internet Protocol Version 4 (TCP/IPv4) > 

- Select: Use the following IP address

Use the following IP address:

IP address:

Subnet mask:

Default gateway:

- Click  twice

4.1.2 Changing the IP Address of the ProtoNode with FieldServer Toolbox

- Ensure that FieldServer Toolbox is loaded onto the local PC. Otherwise, download the
- FieldServer-Toolbox.zip via the Sierra Monitor website's [Software Downloads](#).
- Extract the executable file and complete the installation.
- Double click on the FS Toolbox Utility and click Discover Now on the splash page.
- Find the desired gateway and click the Configure Device button (gear icon) to the right of the gateway information.

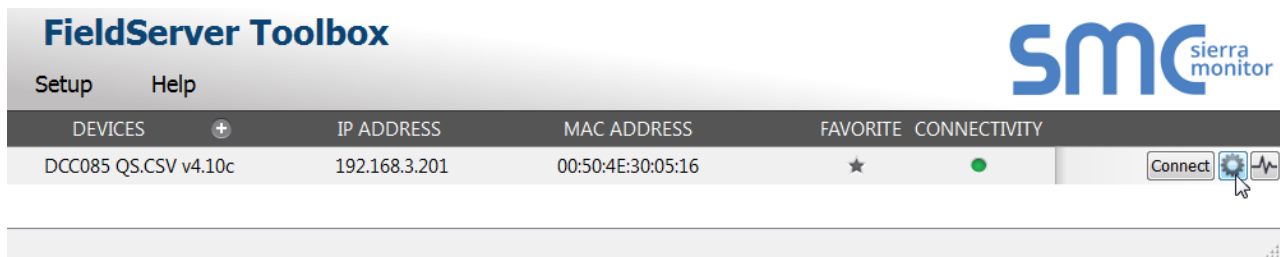

- Select Network Settings in the Configure Device window.

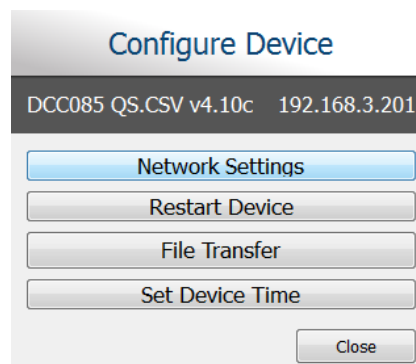

- Modify the IP Address (N1 IP Address field) of the gateway Ethernet port.
 - The following fields may also be changed as needed: Netmask (N1 Netmask field), DHCP Client State (N1 DHCP Client State field), IP Gateway (Default Gateway field) and DNS 1 & 2 (Domain Name Server fields)

NOTE: If the gateway is connected to a router, the Default Gateway field of the gateway should be set to the IP Address of the connected router.

NOTE: Do not change the DHCP Server State (N1 DHCP Server State field).

NOTE: If DNS settings are unknown, set DNS1 to “8.8.8.8” and DNS2 to “8.8.4.4”.

- Click Update IP Settings, then click on the Change and Restart to restart the Gateway and activate the new IP Address.

4.2 Connecting to the ProtoNode Web Configurator

After setting a local PC on the same subnet as the ProtoNode (Section 4.1), open a PC web browser, and enter the IP address of the ProtoNode (default: 192.168.1.24)

NOTE: If the IP Address of the ProtoNode was changed, the assigned IP Address can be discovered using the FS Toolbox utility.

4.3 Configure Auto-Discovery Devices Connected to the Gateway with Discovery Mode

If Auto-Discovery was performed through the S3 DIP switch on power up, skip this step.

- Click the Discovery Mode button at the bottom of the screen.

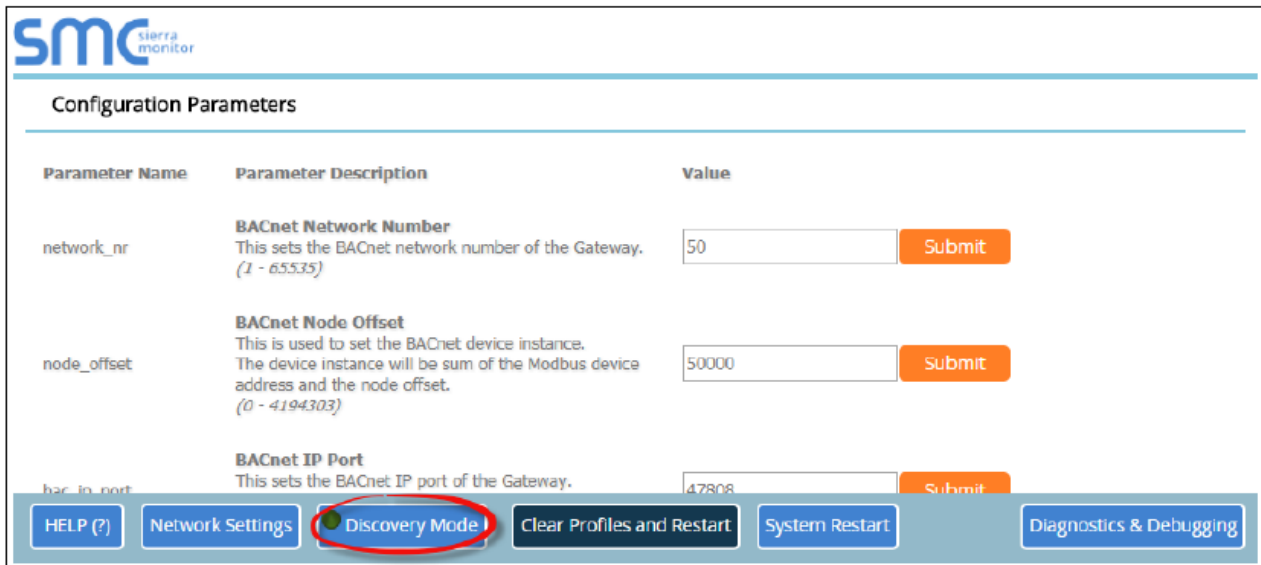

Figure 10: Web Configurator Showing Discovery Mode Button

- Click the OK button in the window that appears to discover devices and restart the device.
- Wait for the ProtoNode to restart and the Discovery in Progress window to disappear.

NOTE: It may take about 3 minutes for all the devices to be discovered and the configuration file to be built.

- If the discovery is successful the desired device profile should appear under the Active profiles title near the bottom of the screen.

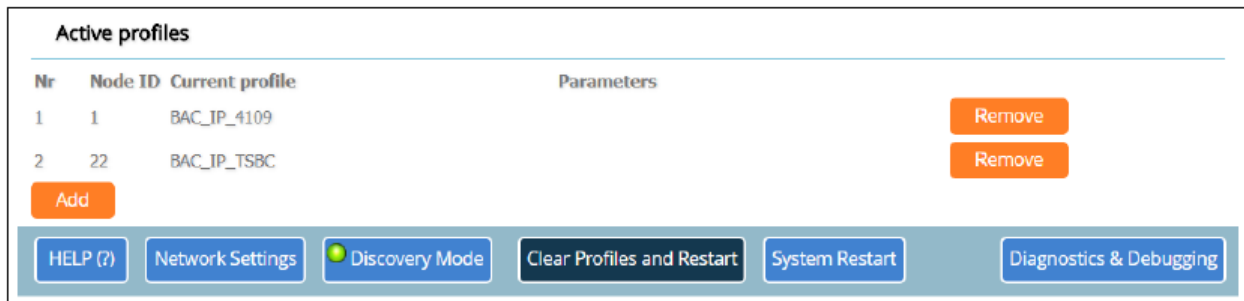

Figure 11: Web Configurator Showing Discovered Profiles

4.4 Selecting Profiles for Devices Connected to ProtoNode

NOTE: If Modbus TCP/IP was selected in Section 3.4 for the Field/BMS protocol, skip this section. Device profiles are NOT used for Modbus TCP/IP.

- In the Web Configurator, the Active Profiles are shown below the Configuration Parameters.
- The Active profiles section lists the currently active device profiles, including previous Web Configurator additions and any devices identified by Auto-Discovery configuration methods. This list is empty for new installations, or after clearing all configurations. **(Figure 12)**



Configuration Parameters

Parameter Name	Parameter Description	Value
network_nr	BACnet Network Number This sets the BACnet network number of the Gateway. <i>(1 - 65535)</i>	<input type="text" value="50"/> Submit
node_offset	BACnet Node Offset This is used to set the BACnet device instance. The device instance will be sum of the Modbus device address and the node offset. <i>(0 - 4194303)</i>	<input type="text" value="50000"/> Submit
bac_ip_port	BACnet IP Port This sets the BACnet IP port of the Gateway. The default is 47808. <i>(1 - 65535)</i>	<input type="text" value="47808"/> Submit
bac_cov_option	BACnet COV This enables or disables COVs for the BACnet connection. Use COV_Enable to enable. Use COV_Disable to disable. <i>(COV_Enable/COV_Disable)</i>	<input type="text" value="COV_Disable"/> Submit
bac_bbmd_option	BACnet BBMD This enables BBMD on the BACnet IP connection. Use BBMD to enable. Use - to disable. The bdt.ini files also needs to be downloaded. <i>(BBMD/-)</i>	<input type="text" value="-"/> Submit
bac_virt_nodes	BACnet Virtual Server Nodes Set to NO if the unit is only converting 1 device to BACnet. Set to YES if the unit is converting multiple devices. <i>(No/Yes)</i>	<input type="text" value="No"/> Submit

Active profiles

Nr	Node ID	Current profile	Parameters
Add			

HELP (?)
Network Settings
Discovery Mode
Clear Profiles and Restart
System Restart
Diagnostics & Debugging

Figure 12: Web Configurator Showing no Active Profiles

- To add an active profile to support a device, click the Add button under the Active Profiles heading. This will present a drop-down box underneath the Current profile column that lists all the available profiles. **(Figure 13)**
- For every device that is added, assign a unique Node-ID. This specification must match the device's network settings.

NOTE: If multiple devices are connected to the ProtoNode, set the BACnet Virtual Server Nodes field to “Yes”; otherwise leave the field on the default “No” setting.

- Once the Profile for the device has been selected from the drop-down list, enter the value of the device’s Node-ID (Modbus address).

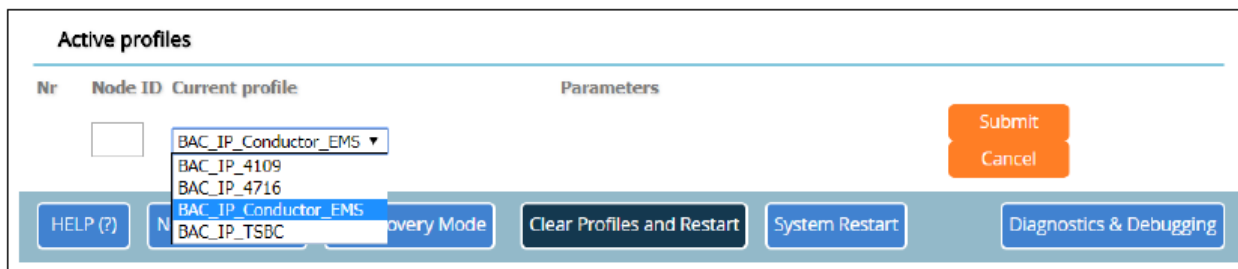

Figure 13: Web Configurator Showing Available Profiles for Selection

- Then press the “Submit” button to add the Profile to the list of devices to be configured.
- Repeat this process until all the devices have been added.
- Completed additions are listed under “Active Profiles” as shown in **Figure 14**.

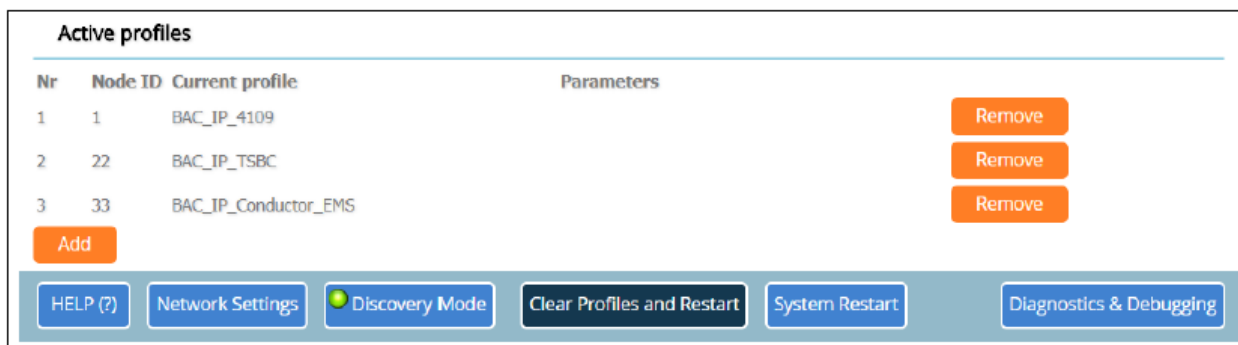
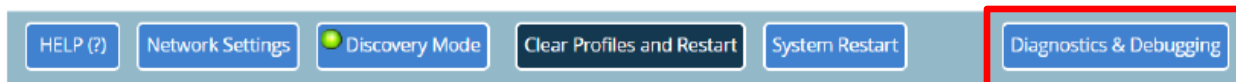

Figure 14: Web Configurator Showing Active Profile Additions

4.5 Set ProtoNode IP Address

When it is necessary to set the BACnet/IP or Modbus TCP ID the following procedure could be followed. Note this is the responsibility of the Energy Management System Administrator.

- Open a PC web browser, enter the default IP address of the ProtoNode 192.168.1.24 and connect to the ProtoNode.
- From the Web GUI’s home page, click the “Diagnostic & Debugging” button.



- After the screen changes, from the left hand side of the screen click on “Setup” and then select “Network Settings” to access the IP Address Settings menu. See image below.

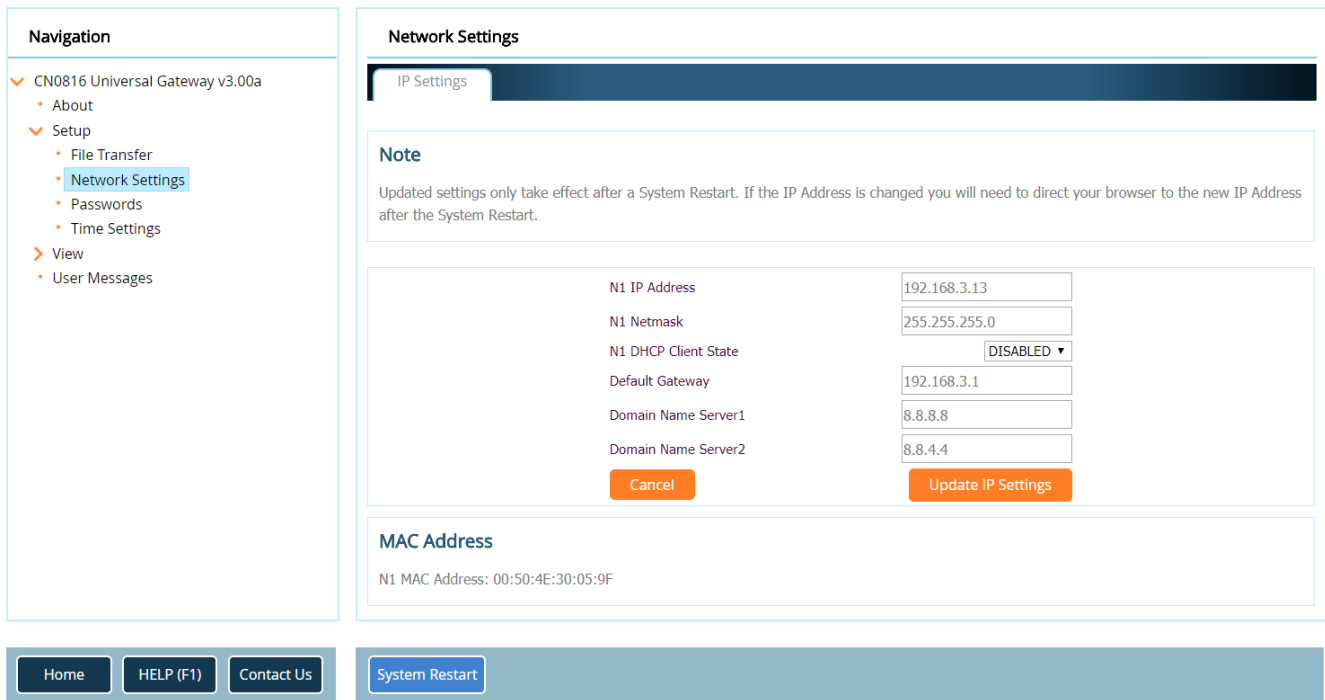

Figure15: Changing IP Address via FS-GUI

- Modify the IP address (N1 IP address field) of the ProtoNode Ethernet port to match EMS network.
- If necessary, change the Netmask (N1 Netmask field).
- If necessary, change the IP Gateway (Default Gateway field)

NOTE: If the ProtoNode is connected to a managed switch/router, the IP Gateway of the ProtoNode should be set to the IP address of that managed switch/router.

- Click the “System Restart” button at the bottom of the page to apply changes and restart the ProtoNode.
- **Record the IP address assigned to the ProtoNode for future reference.**
- **Unplug Ethernet cable from PC and connect it to the network hub or router.**

NOTE: The FieldPoP™ button (see Figure 15) allows users to connect to the SMC Cloud, Sierra Monitor’s device cloud solution for IIoT. The SMC Cloud enables secure remote connection to field devices through a FieldServer and its local applications for configuration, management, maintenance. For more information about the SMC Cloud, refer to the [SMC Cloud Start-up Guide](#).

4.6 BACnet: Setting Node_Offset to Assign Specific Device Instances

- After setting a local PC to the same subnet as the ProtoNode (**Section 5.1**), open a web browser on the PC and enter the IP Address of the ProtoNode.
 - If the IP Address of the ProtoNode has been changed by previous configuration, the assigned IP Address must be gathered from the network administrator
 - The Web Configurator is displayed as the landing page
- Node_Offset field shows the current value (default = 50,000).
 - The values allowed for a BACnet Device Instance can range from 1 to 4,194,303
- To assign a specific Device Instance (or range); change the Node_Offset value as needed using the calculation below:

$$\text{Device Instance (desired)} = \text{Node_Offset} + \text{Node_ID}$$

For example, if the desired Device Instance for the device 1 is 50,001 and the following is true:

- Device 1 has a Node-ID of 1
- Device 2 has a Node-ID of 22
- Device 3 has a Node-ID of 33

Then plug the device 1's information into the formula to find the desired Node_Offset:

$$50,001 = \text{Node_Offset} + 1$$

$$\text{> } 50,000 = \text{Node_Offset}$$

Once the Node_Offset value is input, it will be applied to all devices as shown below:

- Device 1 Instance = 50,000 + Node_ID = 50,000 + 1 = 50,001
- Device 2 Instance = 50,000 + Node_ID = 50,000 + 22 = 50,022
- Device 3 Instance = 50,000 + Node_ID = 50,000 + 33 = 50,033

- Click "Submit" once the desired value is entered.

node_offset

BACnet Node Offset
This is used to set the BACnet device instance.
The device instance will be sum of the Modbus device
address and the node offset.
(0 - 4194303)

Figure 16: Web Configurator Node Offset Field

4.7 How to Start the Installation Over: Clearing Profiles

- After setting a local PC to the same subnet as the ProtoNode (**Section 5.1**), open a web browser on the PC and enter the IP Address of the ProtoNode; the default address is 192.168.1.24.
- If the IP Address of the ProtoNode has been changed by previous configuration, the assigned IP Address must be gathered from the network administrator.
- The Web Configurator is displayed as the landing page.
- At the bottom-left of the page, click the "Clear Profiles and Restart" button.
- Once restart is complete, all past profiles discovered and/or added via Web configurator are deleted. The unit can now be reinstalled.

4.8 Commissioning Lonworks ProtoNode

Commissioning may only be performed by the LonWorks administrator. To commission the ProtoNode LER LonWorks port, insert a small screwdriver in the commissioning hole on the face of the LER's enclosure to access the Service Pin. See the illustration on the ProtoNode LER as to which way to toggle the screw driver during commissioning.



- If an XIF file is required, see steps Section 4.1.1 to generate XIF

4.8.1 Instructions to Upload XIF File From the ProtoNode LER Using FS GUI Web Server

- Connect a standard cat5 Ethernet cable between the PC and ProtoNode
- The Default IP Address of the ProtoNode is **192.168.1.24**, Subnet Mask is **255.255.255.0**. If the PC and the ProtoNode are on different IP Networks, assign a static IP Address to the PC on the 192.168.1.xxx network
- For Windows 10:

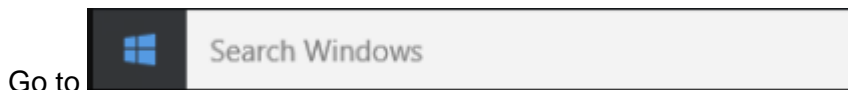

Type "control panel"

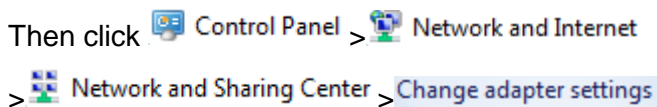

Right-click on Local Area Connection > Properties



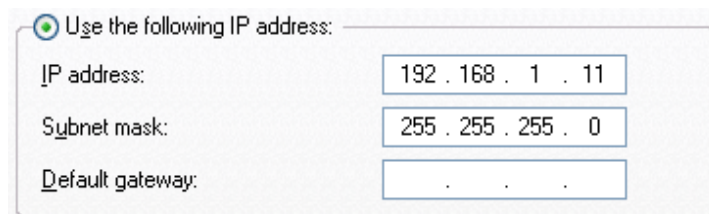

- Select: Use the following IP address

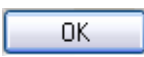

- Click  twice

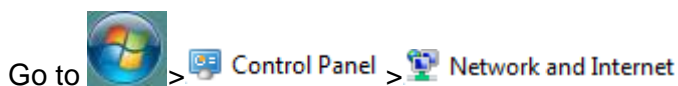
- For Windows 7:



>  Network and Sharing Center > **Change adapter settings**

Right-click on Local Area Connection > Properties

Highlight  Internet Protocol Version 4 (TCP/IPv4) > **Properties**

- Select: Use the following IP address

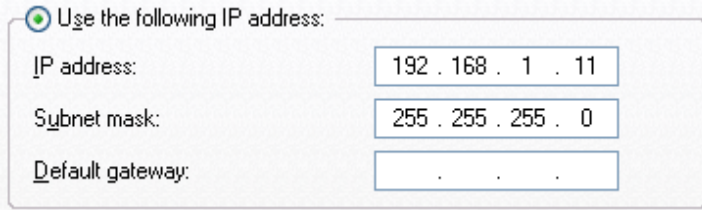

Use the following IP address:

IP address:

Subnet mask:

Default gateway:

- Click  twice
- Open a web browser and go to the following address:
IP address of ProtoCessor/fserver.xif
- Example: **192.168.1.24/fserver.xif**
- Download and save the file onto the PC.



Figure 17: Sample of fserver.xif file being generated

5 FIELD VALIDATING

Chipkin Automation offers a free complementary 2 week fully functional copy of CAS BACnet Explorer that can be used to validate BACnet MS/TP and/or BACnet/IP communications of the ProtoNode in the field without having to have the EMS Integrator on site. A Serial or USB to RS-485 converter is needed to test BACnet MS/TP.

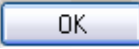
5.1 Downloading Chipkin Automation's CAS Explorer and Requesting an Activation Key

- To request a 2 week complementary BACnet CAS key, go to <http://app.chipkin.com/activation/twoweek/> and fill in all the information. Enter Vendor Code "Burnham012". Once completed, the key will be sent to the email address that was submitted. From this email from Chipkin Automation, the long key will need to be copied and pasted into the CAS key activation page.

Request a two week account activation

You have two choices

1. Activate your account for two weeks

To request a two week account activation, simply complete this form and request a new product key from within the CAS BACnet Explorer.

Note: Your contact info will be used by chipkin to contact you. If your contact info is invalid or you are unreachable your account will be revoked.

Name:	<input type="text"/>
Company:	<input type="text"/>
Address:	<input type="text"/>
Phone number:	<input type="text"/>
Email Address:	<input type="text"/>
Vendor code:	<input type="text"/>
Product:	CAS BACnet Explorer
	<input type="button" value="Request a two week account"/>

1. Purchase

You can buy the CAS BACnet Explorer to get a full account from If you have one, you can use your discount coupon on the web page. [Visit this page](#)

Feel free to [contact us](#) with any questions you may have.

- Go to Chipkin Automation's web site, download, and install the CAS BACnet Explorer to your PC <http://www.chipkin.com/technical-resources/cas-bacnet-explorer/>.
- In the CAS Activation form, enter the email address and paste the CAS key that was sent from Chipkin Automation. Once completed, select Activation.

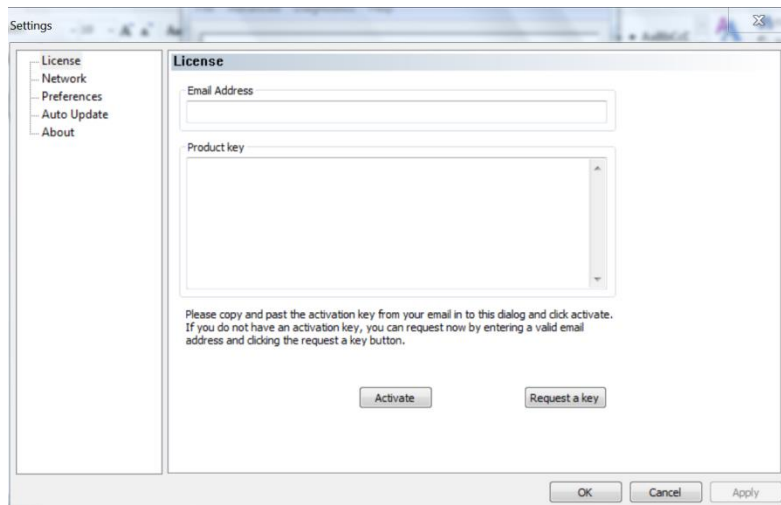

5.2 CAS BACnet Setup

These are the instructions to set CAS Explorer up for the first time on BACnet MS/ST and BACnet/IP.

5.2.1 CAS BACnet MS/TP Setup

- Using the Serial or USB to RS-485 converter, connect it to your PC and the 3 Pin BACnet MS/TP connector on the ProtoNode RER.
- In CAS Explorer, do the following:
 - Click on settings
 - Check the BACnet MSTP box and uncheck the BACnet IP and BACnet Ethernet boxes.
 - Set the BACnet MSTP MAC address to 0.
 - Set the BACnet MSTP Baud Rate to 38400.
 - Click Ok.
 - On the bottom right-hand corner, make sure that the BACnet MSTP box is green.
 - Click on discover.
 - Check all 4 boxes.
 - Click Send.

5.2.2 CAS BACnet IP Setup

- See Section 5.1 to set the IP address and subnet of the PC that will be running the CAS Explorer.
- Connect a straight through or cross Ethernet cable from the PC to the ProtoNode.
- In CAS Explorer, do the following:
 - Click on “Settings”
 - Check the BACnet IP box and uncheck the BACnet MSTP and BACnet Ethernet boxes.
 - In the “Select a Network Device” box, select the network card of the PC by clicking on it.
 - Click “Ok”.
 - On the bottom right-hand corner, make sure that the BACnet IP box is green.
 - Click on “Discover”.
 - Click a “Check” into all 4 boxes.
 - Click “Send”.

Data is now available to view and edit. Select the “+” signs to open the branches and view data from all connected boilers.

6 TROUBLESHOOTING

6.1 LED Diagnostics

Please see the diagram below for ProtoNode RER BACnet and LER LonWorks LED Locations.

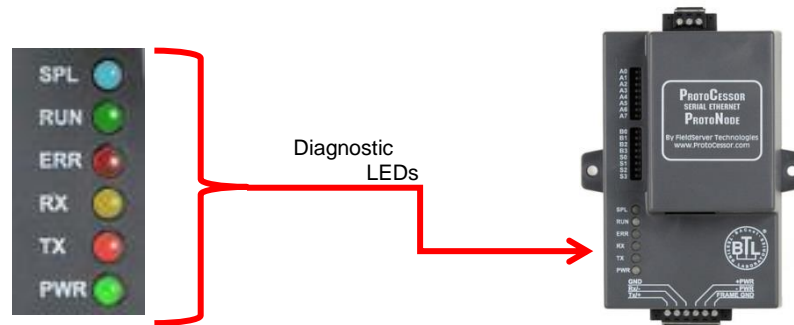

Tag	Description
SPL	The SPL LED will light if the ProtoNode is off line.
RUN	The RUN LED will start flashing 20 seconds after power indicating normal operation.
ERR	The SYS ERR LED will go on solid 15 seconds after power up. It will turn off after 5 seconds. A steady red light will indicate there is a system error on ProtoNode. If this occurs, immediately report the related "system error" shown in the error screen of the GUI interface to FieldServer Technologies for evaluation.
RX	The RX LED will flash when a message is received on the host port.
TX	The TX LED will flash when a message is sent on the host port.
PWR	This is the power light and should show steady green at all times when ProtoNode is powered.

6.2 “No Communication” Troubleshooting Trees

6.2.1 General Troubleshooting

Whenever a setting is changed (i.e. dipswitches or communication) power should be cycled to the ProtoNode to allow for settings to take effect.

1. Is power connected to boilers and ProtoNode?
 - Green PWR LED solid on ProtoNode
 - Green LED solid on control
2. Is the ERR LED red? (see Section 6.1)
3. Is the wiring from the ProtoNode to the Boilers correct? (See sections 3.2 – 3.9)
4. Does each boiler have a unique address? (see section 2.1)
5. For TSBC boilers, are the Parity and Baud rate set correctly? (see section 2.1.3)
6. Does the ProtoNode Discover boilers but give zero for values?
 - The ProtoNode has remembered older profiles and must be cleared.
 - Connect a PC using an Ethernet cable.
 - Go to 192.168.1.24 ProtoNode profile internet explorer page
 - Select “Clear Profiles And Restart”

For further “No Communication” Troubleshooting, go to the Network Protocol of the EMS Network and follow the Troubleshooting tree under it.

6.2.2 BACnet IP Troubleshooting

1. Are the “S Bank” Dipswitches set to BACnet IP? (See section 2.2.1)
2. Is the wiring to the EMS Network Correct? (See section 4.2 – 4.4)
3. Does the Baud Rate of the ProtoNode match the Baud Rate of the network (see section 2.2.4)
4. Has an Auto-Discovery been performed? (See section 2.2.2)

6.2.3 BACnet MS/TP Troubleshooting

1. Are the “S Bank” Dipswitches set to BACnet MS/TP? (See section 2.2.1)
2. Is the wiring to the EMS Network Correct? (See section 3.11)
3. Is the MAC address between 1 – 127 AND unique on the EMS network? (Section 2.2.3)
4. Does the Baud Rate of the ProtoNode match the Baud Rate of the network (see section 2.2.4)
5. Has an Auto-Discovery been performed? (See section 2.2.2)

6.2.4 Metasys N2 Troubleshooting

1. Are the “S Bank” Dipswitches set to Metasys N2? (See section 2.2.1)
2. Is the wiring to the EMS Network Correct? (See section 3.11)

6.2.5 Lonworks troubleshooting

1. Is the wiring to the EMS Network Correct? (See section 4.1)
2. Has an Auto-Discovery been performed? (See section 2.2.2)

6.3 Take Diagnostic Capture with FieldServer Utilities

- Once the log is complete, email it to support@processor.com. The log will allow us to rapidly diagnose the issue.
- Make sure the FieldServer Toolbox is loaded on the PC that the ProtoNode is connected to.
- Toolbox is found at: <http://www.sierramonitor.com/customer-care/resource-center> > Software Downloads > FieldServer Toolbox



Figure 18: Ethernet port location of the ProtoNode



- After FieldServer Toolbox has been installed, disable any Wireless Network Connection adapters on the PC/Laptop.
- Disable firewall and virus protection software.
- Connect a standard Cat5 Ethernet cable between the PC and the ProtoNode.

6.3 Take Diagnostic Capture with FieldServer Utilities (continued)



- The Default IP Address of the ProtoNode is **192.168.1.24**, Subnet Mask is **255.255.255.0**. If the PC and the ProtoNode are on different IP Networks, assign a static IP Address to the PC on the 192.168.1.xxx network.
- For Windows 10:

Go to 





Type "control panel"

Then click  Control Panel >  Network and Internet
>  Network and Sharing Center > [Change adapter settings](#)



Right-click on Local Area Connection > Properties

Highlight  Internet Protocol Version 4 (TCP/IPv4) > 

- For Windows 7:

Go to  >  Control Panel >  Network and Internet
>  Network and Sharing Center > [Change adapter settings](#)

Right-click on Local Area Connection > Properties

Highlight  Internet Protocol Version 4 (TCP/IPv4) > 

- For Windows 10 and Windows 7, select: Use the following IP address

Use the following IP address:

IP address:	<input type="text" value="192 . 168 . 1 . 11"/>
Subnet mask:	<input type="text" value="255 . 255 . 255 . 0"/>
Default gateway:	<input type="text" value=" . . ."/>

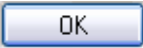
- Click  twice
- Double click on the FieldServer Toolbox.

6.3 Take Diagnostic Capture with FieldServer Utilities (continued)

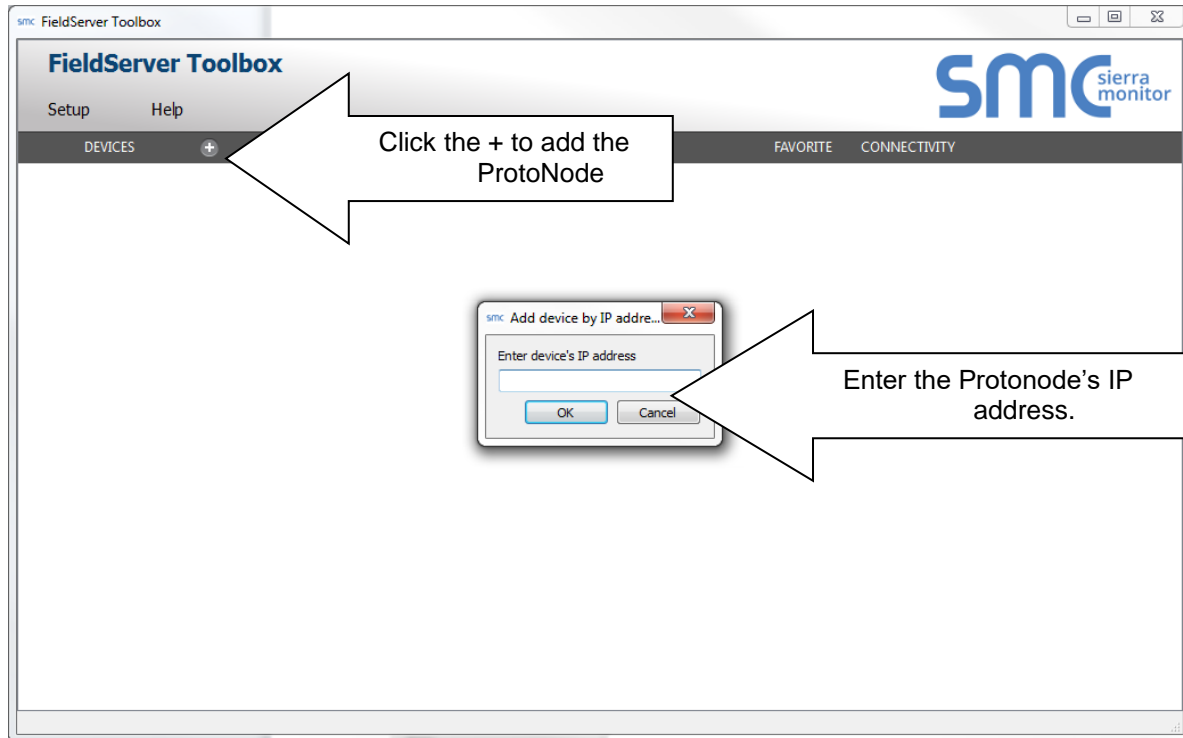

- **Step 1: Take a Log**
 - Click on the diagnose icon  of the desired device.

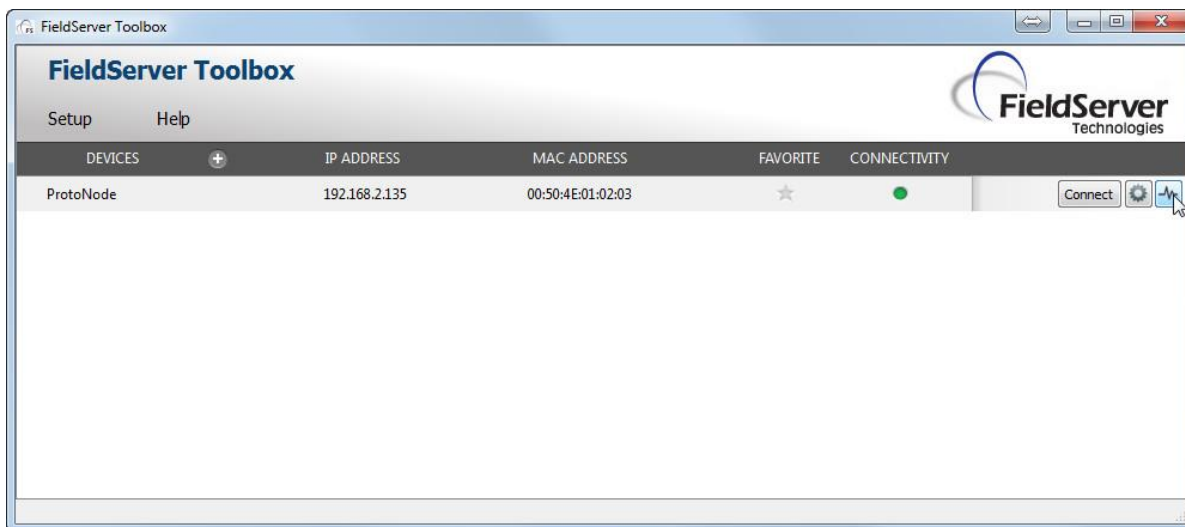

6.3 Take Diagnostic Capture with FieldServer Utilities (continued)

- Select full Diagnostic

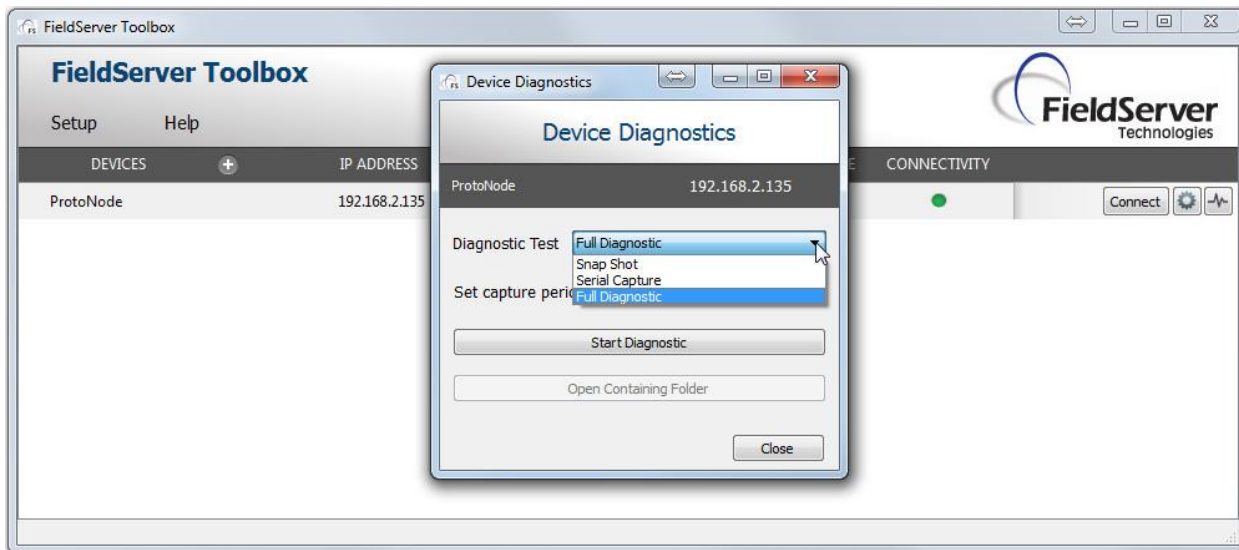

- If desired, the default capture period can be changed.
- Click on Start Diagnostic

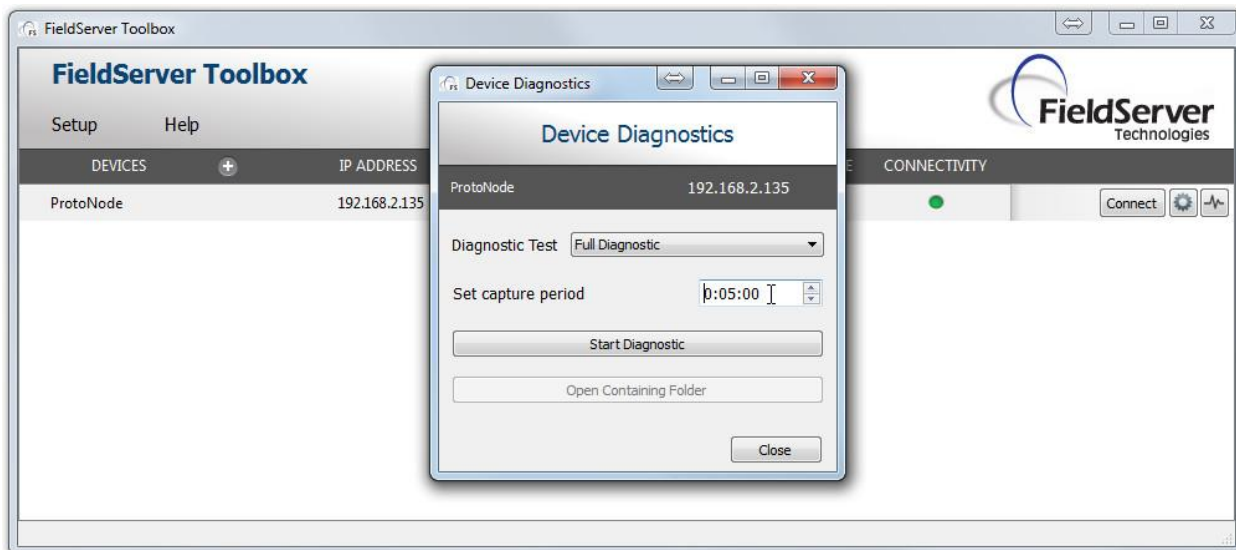

- Wait for Capture period to finish. Diagnostic Test Complete window will appear.
- If Diagnostic Test Complete window does not appear after “Set Capture Period” is over, the diagnostic log may be found in the FieldServer directory (likely on the computer’s C Drive or under Program Files) :

■ C: Drive > FieldServer > FieldServer Toolbox > Config > Diagnostic_XXXX-XX-XX_XX-XX (The X’s will be the date and time the log was taken)

- **Step 2:** Send Log

- Once the Diagnostic test is complete, a .zip file will be saved on the PC.

6.3 Take Diagnostic Capture with FieldServer Utilities (continued)

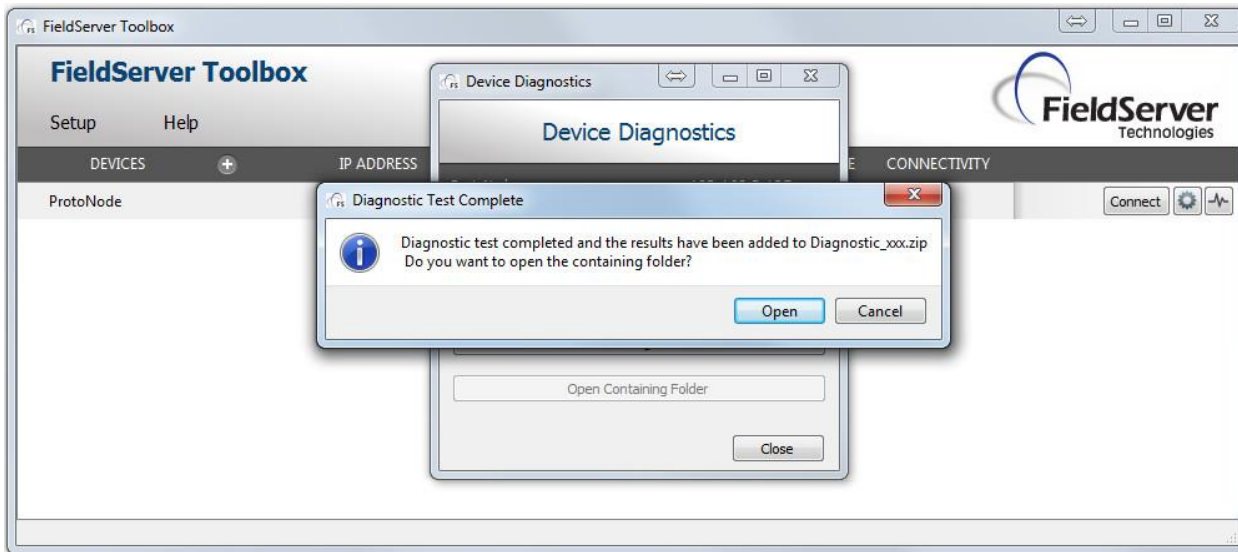

- Choose open to launch explorer and have it point directly at the correct folder. Send the Diagnostic zip file to support@fieldserver.com

 Diagnostic_2014-07-17_20-15.zip 2014/07/17 20:16 zip Archive 676 KB

- If Diagnostic Test Complete window does not appear after “Set Capture Period” is over, the diagnostic log may be found in the FieldServer directory (likely on the computer’s C Drive or under Program Files) :
 - C: Drive > FieldServer > FieldServer Toolbox > Config > Diagnostic_XXXX-XX-XX_XX-XX (The X’s will be the date and time the log was taken)
 - Send this folder instead of the .zip file

7 PROTONODE INFORMATION

7.1 Specifications and Ordering Information

	ProtoNode RER BACnet	ProtoNode LER LonWorks
Protocol	BACnet MS/TP, BACnet/IP, Metasys N2 Open, or Modbus TCP	LonWorks
ProtoNode Part Number	Part Number: 106416-01 FieldServer #: FPC-N34-0816	Part Number: 106418-01 FieldServer #: FPC-N35-0817
Electrical Connections	One 6-pin Phoenix connector, one RS-485 +/- ground port, power +/- frame ground port One 3-pin RS-485 Phoenix connector, one RS-485 +/- ground port One Ethernet-10/100 Ethernet port	One 6-pin Phoenix connector, one RS-485 +/- ground port, power +/- frame ground port One Ethernet 10/100 Base T port One FTT-10 LonWorks port
Approvals	CE Certified; TUV approved to UL 916, EN 60950-1, EN 50491-3 and CSA C22-2 standards; FCC Class A Part 15; DNP3 Conformance Tested; OPC Self-tested for Compliance; RoHS Compliant; CSA 205 Approved	
	BTL Marked	LonMark Certified
Operating Temperature	-40°C to 75°C (-40°F to 167°F)	
Humidity	5 - 90% RH (non-condensing)	
Power Requirements	Multi-mode power adapter: 9-30VDC or 12 - 24VAC	
Operating Temperature:	-40°C to 75°C (-40°F to 167°F)	
Physical Dimensions	11.5 cm L x 8.3 cm W x 4.1 cm H (4.5 x 3.2 x 1.6 in.)	
Weight:	0.2 kg (0.4 lbs)	

Boiler Communication Statistics

Protocol	Modbus RTU
Baud Rate	38400
Parity	None
Data Bits	8
Stop Bits	1

Ordering information

	ProtoNode RER BACnet	ProtoNode LER LonWorks
Universal Gateway (ProtoNode)	PN: 106416-01	PN: 106418-01
Universal Gateway I&O	PN: 106417-01	PN: 106417-01
Universal Gateway Kit (Includes ProtoNode and I&O)	PN: 106432-01	PN: 106433-01

7.2 ProtoNode Detailed View

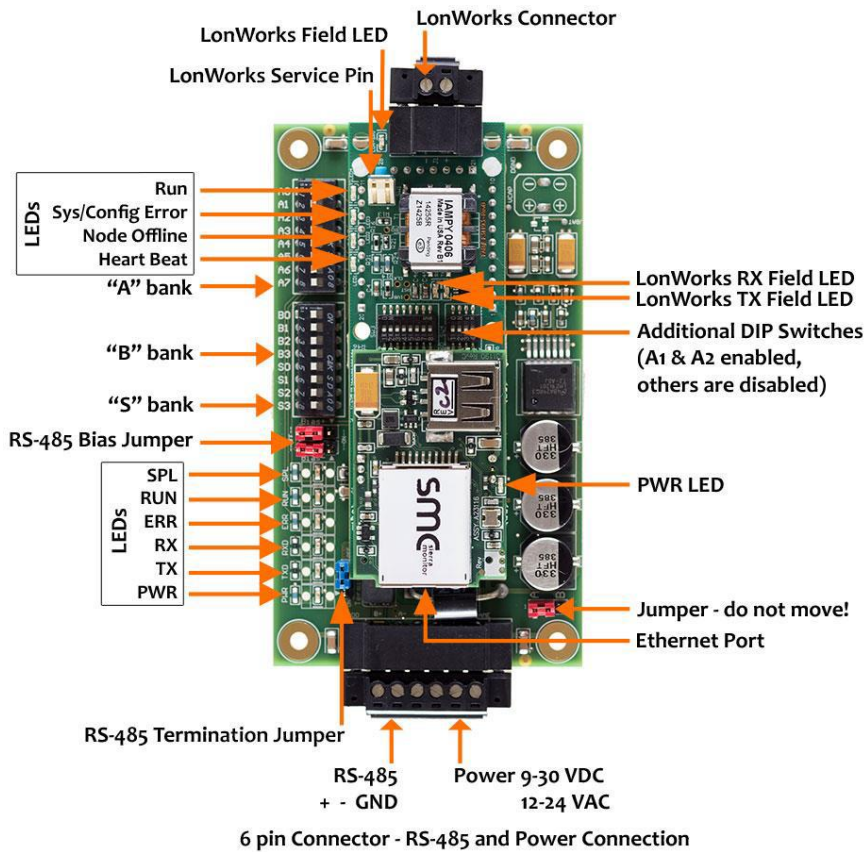
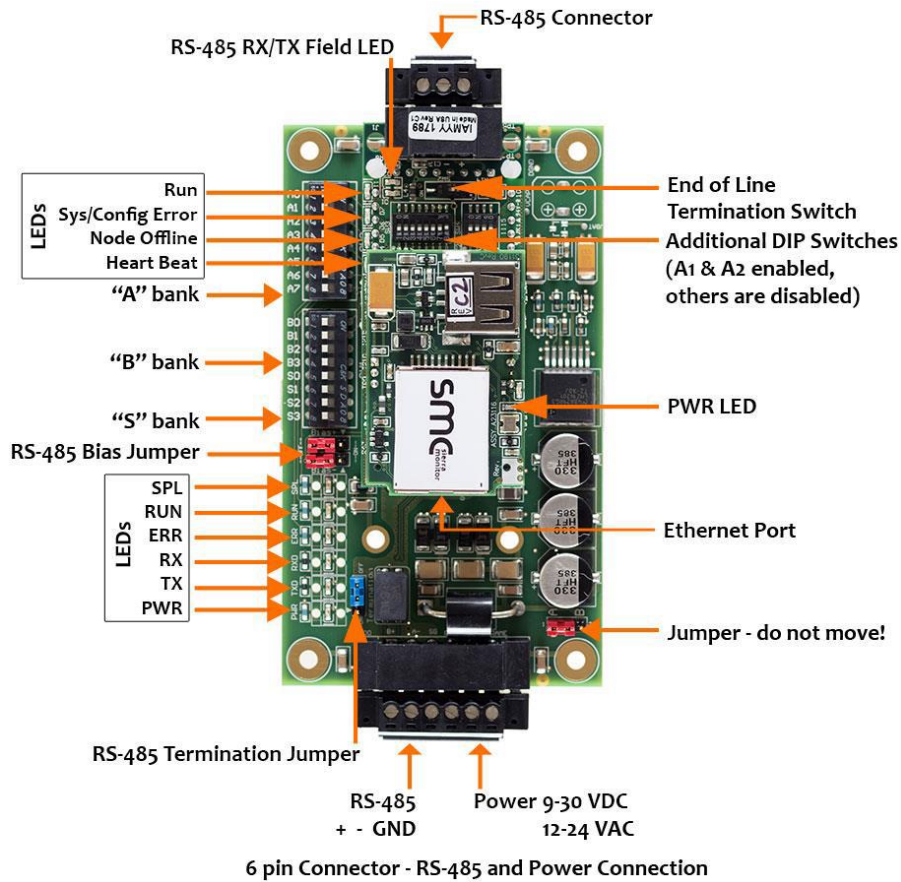

Appendix A. TSBC Points list

BACnet, N2 and LonWorks Points

	Read/ Write	BACnet	N2	LonWorks		Read/ Write	BACnet
Point Name		Data Type	Object Id	Data Type	Pt Addr	Lon Name	Lon SNVT Type
Outdoor Air Reset Enable/Disable		BI	1	DI	1	nvoOAResEnDs_XXX	SNVT_switch
Domestic Hot Water Priority		BI	2	DI	2	nvoDmHtWtPri_XXX	SNVT_switch
Local/Remote		BI	3	DI	3	nvoLoc_Rem_XXX	SNVT_switch
Remote On/Off Modbus Command	R/W	BV	4	DO	4	nvi/nvoRmOnOfCmd_XXX	SNVT_switch
Spare Input (Programmable)		BI	5	DI	5	nvoSprInput_XXX	SNVT_switch
Low Water Cutoff Switch		BI	6	DI	6	nvoLoWtCtOff_XXX	SNVT_switch
Burner On/Off Switch		BI	7	DI	7	nvoBrnOnOfSw_XXX	SNVT_switch
Low Water Flow		BI	8	DI	8	nvoLoWtrFLo_XXX	SNVT_switch
High and Low Gas Pressure Switches		BI	9	DI	9	nvoHiLoGsPrs_XXX	SNVT_switch
Operating or High Limit		BI	10	DI	10	nvoOpOrHiLim_XXX	SNVT_switch
Low Combustion Air Flow		BI	11	DI	11	nvoLoCmbArFI_XXX	SNVT_switch
Fuel Valve Energized		BI	12	DI	12	nvoFIVlvEnrg_XXX	SNVT_switch
Flame Safeguard Alarm		BI	13	DI	13	nvoFlmSfgdAl_XXX	SNVT_switch
Call For Heat (CFH)		BI	14	DI	14	nvoCallForHt_XXX	SNVT_switch
General Alarm		BI	15	DI	15	nvoGenAlm_XXX	SNVT_switch
Vent Inducer		BI	16	DI	16	nvoVntIndcr_XXX	SNVT_switch
Boiler Pump		BI	17	DI	17	nvoBlrPump_XXX	SNVT_switch
System Pump		BI	18	DI	18	nvoSystPmp_XXX	SNVT_switch
Spare Output (Programmable)		BI	19	DI	19	nvoSprOutput_XXX	SNVT_switch
State Boiler Disabled		BI	20	DI	20	nvoStBlrDis_XXX	SNVT_switch
State Weather Shutdown		BI	21	DI	21	nvoStWthShdn_XXX	SNVT_switch
State Lockout		BI	22	DI	22	nvoStLockout_XXX	SNVT_switch
State Pump Purge		BI	23	DI	23	nvoStPmpPurg_XXX	SNVT_switch
State Limit Hold		BI	24	DI	24	nvoStLimHold_XXX	SNVT_switch
State Purge/Pilot Ign		BI	25	DI	25	nvoStPrgPIlg_XXX	SNVT_switch
State Low Fire/Ignition		BI	26	DI	26	nvoStLoFirIlg_XXX	SNVT_switch
State Main Ignition		BI	27	DI	27	nvoStMainIgn_XXX	SNVT_switch
State Low Fire Hold		BI	28	DI	28	nvoStLoFrHld_XXX	SNVT_switch
State Boiler Running		BI	29	DI	29	nvoStBlrRun_XXX	SNVT_switch
State Fan Post Purge		BI	30	DI	30	nvoStFnPstPg_XXX	SNVT_switch
State Pump Cool Down		BI	31	DI	31	nvoStPmpCIDn_XXX	SNVT_switch
State Standby		BI	32	DI	32	nvoStStandby_XXX	SNVT_switch
Annunciator Low Water Level		BI	33	DI	33	nvoAnLoWtLvl_XXX	SNVT_switch
Annunciator Off Switch		BI	34	DI	34	nvoAnnOffSw_XXX	SNVT_switch
Annunciator Low Water Flow		BI	35	DI	35	nvoAnLoWtFlo_XXX	SNVT_switch
Annunciator Fuel Limit		BI	36	DI	36	nvoAnnFILim_XXX	SNVT_switch
Annunciator High Temp Limit		BI	37	DI	37	nvoAnHiTmpLm_XXX	SNVT_switch
Annunciator Low Air Flow		BI	38	DI	38	nvoAnLoArFlo_XXX	SNVT_switch
Annunciator FSG Lockout		BI	39	DI	39	nvoAnFSGLkot_XXX	SNVT_switch
Annunciator Outlet Temp Fail		BI	40	DI	40	nvoAnOtItpFI_XXX	SNVT_switch
Annunciator Inlet Temp Fail		BI	41	DI	41	nvoAnInItpFI_XXX	SNVT_switch

Annunciator OA Temp Fail		BI	42	DI	42	nvoAnOATmpFI_XXX	SNVT_switch
Annunciator Remote Temp Fail		BI	43	DI	43	nvoAnRemTpFI_XXX	SNVT_switch
Annunciator Remote In Fail		BI	44	DI	44	nvoAnRemInFI_XXX	SNVT_switch
Annunciator Comm Fail		BI	45	DI	45	nvoAnComFI_XXX	SNVT_switch
Annunciator Low Inlet Temp		BI	46	DI	46	nvoAnLoInlTp_XXX	SNVT_switch
Annunciator Memory Failure		BI	47	DI	47	nvoAnnMemFI_XXX	SNVT_switch
Boiler Outlet Water Temp		AI	48	AI	48	nvoBIOtWtTp_XXX	SNVT_temp_p
Boiler Inlet Water Temp		AI	49	AI	49	nvoBIInlWtTp_XXX	SNVT_temp_p
Outside Air Temp		AI	50	AI	50	nvoOATmp_XXX	SNVT_temp_p
Boiler Actual SP		AI	51	AI	51	nvoBlrActSP_XXX	SNVT_temp_p
Remote System Temp		AI	52	AI	52	nvoRemSysTmp_XXX	SNVT_temp_p
Remote Firing Rate or Remote SP	R/W	AV	53	AO	53	nvi/nvoRmFrRatSP_XXX	SNVT_count_f
PCB Temp Sensor		AI	54	AI	54	nvoPCBTmpSen_XXX	SNVT_temp_p
Firing Rate Output to Mod Motor		AI	55	AI	55	nvoFrRtOtMod_XXX	SNVT_lev_percent
Minimum Return Temp SP		AI	56	AI	56	nvoMnRetTpSP_XXX	SNVT_temp_p
Mixing Valve Output		AI	57	AI	57	nvoMixVlvOut_XXX	SNVT_lev_percent
Control Mode		AI	58	AI	58	nvoCtrlMode_XXX	SNVT_count_f

Modbus Points

Modbus Register Address	Description	Read/Write	Engineering Units for Register = 0	Engineering Units for Register = 100	Units	Notes
40001	Boiler Outlet Water Temperature		-50	300	F	
40002	Boiler Inlet Water Temperature		-50	300	F	
40003	Outside Air Temperature		-50	300	F	
40004	Boiler Actual Setpoint		60	230	F	
40005	Remote System Temperature		-50	300	F	
40006	Remote Firing Rate or Remote Setpoint	Y	0	100 or 300	% or F	1
40007	PCB Temperature Sensor		-50	300	F	
40008	Firing Rate Output to Mod Motor		0	100	%	
40009	Minimum Return Temperature Setpoint		110	180	F	
40010	Mixing Valve Output		0	100	%	
40011	Control Mode		1	7		

Coil Address

Coil Address	Description	Read/Write	coil = 0	coil = 1	Notes
00001	Outdoor Air Reset Enable/Disable		Disable	Enable	
00002	Domestic Hot Water Priority (DHWP)		Disable	Enable	
00003	Local / Remote		Local	Remote	
00004	Remote On / Off Modbus Command	Y	Off	On	1
00005	Spare Input (Programmable)		Off	On	
00006	Low Water Cutoff Switch		Off	On	2
00007	Burner On / Off Switch		Off	On	2
00008	Low Water Flow		Off	On	2

Coil Address	Description	Read/Write	coil = 0	coil = 1	Notes
00009	High and Low Gas Pressure Switches		Off	On	2
00010	Operating or High Limit		Off	On	2
00011	Low Combustion Air Flow		Off	On	2
00012	Fuel Valve Energized		Off	On	
00013	Flame Safeguard Alarm		Off	On	
00014	Call For Heat (CFH)		Off	On	
00015	General Alarm		Off	On	4
00016	Vent Inducer		Off	On	
00017	Boiler Pump		Off	On	
00018	System Pump		Off	On	
00019	Spare Output (Programmable)		Off	On	
00020	State Boiler Disabled		Off	On	3
00021	State Weather Shutdown		Off	On	3
00022	State Lockout		Off	On	3
00023	State Pump Purge		Off	On	3
00024	State Limit Hold		Off	On	3
00025	State Purge/Pilot Ign		Off	On	3
00026	State Low Fire/Ignition		Off	On	3
00027	State Main Ignition		Off	On	3
00028	State Low Fire Hold		Off	On	3
00029	State Boiler Running		Off	On	3
00030	State Fan Post Purge		Off	On	3
00031	State Pump Cool Down		Off	On	3
00032	State Standby		Off	On	3
00033	Annunciator Low Water Level		Off	On	4
00034	Annunciator Off Switch		Off	On	4
00035	Annunciator Low Water Flow		Off	On	4
00036	Annunciator Fuel Limit		Off	On	4
00037	Annunciator High Temp Limit		Off	On	4
00038	Annunciator Low Air Flow		Off	On	4
00039	Annunciator FSG Lockout		Off	On	4
00040	Annunciator Outlet Temp Fail		Off	On	4
00041	Annunciator Inlet Temp Fail		Off	On	4
00042	Annunciator OA Temp Fail		Off	On	4
00043	Annunciator Remote Temp Fail		Off	On	4
00044	Annunciator Remote In Fail		Off	On	4
00045	Annunciator Comm Fail		Off	On	4
00046	Annunciator Low Inlet Temp		Off	On	4
00047	Annunciator Memory Failure		Off	On	4

Appendix B. Apex with Panasonic (4109) Points List

WARNING: All parameters are stored in EEPROM. Only perform writes when it is **absolutely necessary** to change the value of a register. Care must be taken to avoid excessive writing to parameters stored in EEPROM memory.

BACnet, N2 and LonWorks Points

Point Name	Read/Write	BACnet		N2		LonWorks	
		Data Type	Data ID	Data Type	Pnt Addr	Lon Name	Lon SNVT
Burner On Off (See Note 1)	R/W	BV	1	DO	1	nvi/nvoBrnrOnOff_XXX	SNVT_switch
Demand Source		AI	2	AI	2	nvoDem_Src_XXX	SNVT_count_f
CH Setpoint (See Note 2)	R/W	AV	3	AO	3	nvi/nvoCH_SP_XXX	SNVT_temp_p
DHW Setpoint	R/W	AV	4	AO	4	nvi/nvoDHW_SP_XXX	SNVT_temp_p
Lead Lag Setpoint	R/W	AV	5	AO	5	nvi/nvoLL_SP_XXX	SNVT_temp_p
CH TOD Setpoint	R/W	AV	6	AO	6	nvi/nvoCH_TOD_SP_XXX	SNVT_temp_p
CH Setpoint Source		AI	7	AI	7	nvoCH_SP_Src_XXX	SNVT_count_f
Active CH Setpoint		AI	8	AI	8	nvoAct_CH_SP_XXX	SNVT_temp_p
DHW Setpoint Source		AI	9	AI	9	nvoDHW_SPSrc_XXX	SNVT_count_f
Active DHW Setpoint		AI	10	AI	10	nvoActDHW_SP_XXX	SNVT_temp_p
LL Master Setpoint Source		AI	11	AI	11	nvoLLMstSPSr_XXX	SNVT_count_f
Active LL Setpoint		AI	12	AI	12	nvoAct_LL_SP_XXX	SNVT_temp_p
Supply Sensor		AI	13	AI	13	nvoSupSensor_XXX	SNVT_temp_p
Return Sensor		AI	14	AI	14	nvoRetSensor_XXX	SNVT_temp_p
Header Sensor		AI	15	AI	15	nvoHdrSensor_XXX	SNVT_temp_p
Stack Sensor		AI	16	AI	16	nvoStkSensor_XXX	SNVT_temp_p
Outdoor Sensor		AI	17	AI	17	nvoOtdrSensr_XXX	SNVT_temp_p
4-20 mA Rem Control Input		AI	18	AI	18	nvoRemCtrlIn_XXX	SNVT_count_f
Fan Speed		AI	19	AI	19	nvoFan_Speed_XXX	SNVT_count_f
Flame Signal		AI	20	AI	20	nvoFlmSig_XXX	SNVT_count_f
Burner Control State		AI	21	AI	21	nvoBrnCtrlSt_XXX	SNVT_count_f
Lockout Code		AI	22	AI	22	nvoLockotCod_XXX	SNVT_count_f
Hold Code		AI	23	AI	23	nvoHoldCode_XXX	SNVT_count_f
Burner Cycle Count	R/W	AV	24	AO	24	nvi/nvoBrnCycCnt_XXX	SNVT_count_f
Burner Run Time	R/W	AV	25	AO	25	nvi/nvoBrnRunTim_XXX	SNVT_time_hour
System Pum Cycle Count	R/W	AV	26	AO	26	nvi/nvoSysPmCyCt_XXX	SNVT_count_f
DHW Pump Cycle Count	R/W	AV	27	AO	27	nvi/nvoDHWpPmCyCt_XXX	SNVT_count_f
Boiler Pump Cycle Count	R/W	AV	28	AO	28	nvi/nvoBlrPmCyCt_XXX	SNVT_count_f

Note 1, If only the burner on/off Modbus signal is used instead of the Enable / Disable contact input the boiler will be turned off but the system pump may remain running.

Note 2, when writing CH Setpoint the Energy Management System is responsible for the boiler's setpoint for central heating. Disable the boiler's Outdoor Air Reset function. **WARNING:** All parameters are stored in EEPROM. Only perform writes when it is **absolutely necessary** to change the value of a register. Care must be taken to avoid excessive writing to parameters stored in EEPROM memory.

Modbus Points

Modbus Register	Protocol Name	Description	Read/Write
Enable / Disable			
400,203	Burner on/off	Enable / disable burner. 1 = on 0 = off	R/W
400,006	Demand source	0 = Unknown 1 = No source demand 2 = Central heat 3 = Domestic hot water 4 = Lead Lag slave 5 = Lead Lag master 6 = Central heat frost protection 7 = Domestic hot water frost protection 8 = No demand due to burner switch turned off 9 = Domestic hot water storage 11 = Warm weather shutdown	R
Setpoints			
410,211	CH setpoint	Use this register to change the boiler setpoint. valid range 79 F (26.1 C) to 191 F (88.3 C)	R/W
410,453	DHW setpoint	Use this register to change the domestic hot water setpoint. valid range 79 F (26.1 C) to 191 F (88.3 C)	R/W
410,546	Lead Lag setpoint	Use this register to change the lead lag setpoint. valid range 79 F (26.1 C) to 191 F (88.3 C)	R/W
410,212	CH TOD setpoint	Use this register to change the central heat 'time of day' setpoint valid range 79 F (26.1 C) to 191 F (88.3 C)	R/W
410,065	CH setpoint source	0=Unknown, 1=Normal setpoint, 2=TOD setpoint, 3=Outdoor reset, 4=Remote control (4-20mA), 7=Outdoor reset time of day	R
410,016	Active CH setpoint	-40 F (-40°C) to 266 F (130°C) Setpoint determined by CH setpoint source (register 65).	R
410,081	DHW setpoint source	0=Unknown, 1=Normal setpoint, 2=TOD setpoint, 5=DHW tap setpoint, 6=DHW preheat setpoint	R
410,017	Active DHW setpoint	-40 F (-40°C) to 266 F (130°C) Setpoint determined by DHW setpoint source (register 81).	R
410,162	Lead Lag master setpoint source	0=Unknown, 1=CH setpoint, 2=CH TOD setpoint, 3=Outdoor reset, 4=Remote control (4-20mA), 5=DHW setpoint, 6=DHW TOD setpoint, 7=Outdoor reset time of day, 8=Mix setpoint	R

Modbus Register	Protocol Name	Description	Read/Write
410,018	Active LL setpoint	-40 F (-40°C) to 266 F (130°C) Setpoint determined by LL setpoint source (register 162).	R
Temperature Sensors			
410,007	Supply sensor	-40 F (-40°C) to 266 F (130°C)	R
410,011	Return sensor	-40 F (-40°C) to 266 F (130°C)	R
410,013	Header sensor	-40 F (-40°C) to 266 F (130°C)	R
410,014	Stack sensor	-40 F (-40°C) to 266 F (130°C)	R
410,170	Outdoor sensor	-40 F (-40°C) to 266 F (130°C)	R
400,015	4 - 20 mA remote control input	mA value for S2 (J8-6) parameter selectable as (remote set point) & (remote modulation)	R
Burner			
400,009	Fan speed	Speed of the combustion air blower in rpm	R
400,010	Flame signal	0.01V or 0.01µA precision (0.00-50.00V)	R
400,033	Burner control state	0 Initiate 1 Standby Delay 2 Standby 3 Safe Startup 4 Prepurge - Drive to Purge Rate 5 Prepurge – Measured Purge Time 6 Prepurge – Drive to Lightoff Rate 7 Preignition Test 8 Preignition Time 9 Pilot Flame Establishing Period 10 Main Flame Establishing Period 11 Direct Burner Ignition 12 Run 13 Postpurge 14 Lockout	R
Trouble Shooting			
410,034	Lockout code	Reasons for burner lockout 0 No lockout, 4 Supply high limit 5 DHW high limit 6 Stack High limit 12 Flame detected out of sequence 18 Lightoff rate proving failed 19 Purge rate proving failed 20 Invalid Safety Parameters 21 Invalid Modulation Parameter 22 Safety data verification needed 23 24VAC voltage low/high 24 Fuel Valve Error 25 Hardware Fault 26 Internal Fault 27 Ignition Failure	R

Modbus Register	Protocol Name	Description	Read/Write
410,040	Hold code	Reason for burner hold 0 None 1 Anti short cycle 2 Boiler Safety Limit Open 3 Boiler Safety Limit Open, (ILK Off) 7 Return sensor fault 8 Supply sensor fault 9 DHW sensor fault 10 Stack sensor fault 11 Ignition failure 13 Flame rod shorted to ground 14 Delta T inlet/outlet high 15 Return temp higher than supply 16 Supply temp has risen too quickly 17 Fan speed not proved 23 24VAC voltage low/high 25 Hardware Fault 27 Ignition Failure	R
Statistics			
400,128-400,129	Burner cycle count	0-999,999 (U32)	R/W
400,130-400,131	Burner run time	Hours (U32)	R/W
400,132-400,133	System pump cycle count	0-999,999 (U32)	R/W
400,134-400,135	DHW pump cycle count	0-999,999 (U32)	R/W
400,138-400,139	Boiler pump cycle count	0-999,999 (U32)	R/W

Appendix C. Concert Control or Apex with Panasonic (4716) Points List

BACnet, N2 and LonWorks Points

Point Name	Read/Write	BACnet		N2		LonWorks	
		Data Type	Data Id	Data Type	Pt Addr	Lon Name	Lon SNVT Type
Burner On Off	R	BV	1	DO	1	nvi/nvoBrnrOnOff_XXX	SNVT_switch
Demand Source	R	AI	2	AI	2	nvoDem_Src_XXX	SNVT_count_f
CH Setpoint	R	AV	3	AO	3	nvi/nvoCH_SP_XXX	SNVT_temp_p
DHW Setpoint	R	AV	4	AO	4	nvi/nvoDHW_SP_XXX	SNVT_temp_p
Lead Lag Setpoint	R	AV	5	AO	5	nvi/nvoLL_SP_XXX	SNVT_temp_p
CH TOD Setpoint	R	AV	6	AO	6	nvi/nvoCH_TOD_SP_XXX	SNVT_temp_p
CH Setpoint Source	R	AI	7	AI	7	nvoCH_SP_Src_XXX	SNVT_count_f
Active CH Setpoint	R	AI	8	AI	8	nvoAct_CH_SP_XXX	SNVT_temp_p
DHW Setpoint Source	R	AI	9	AI	9	nvoDHW_SPSrc_XXX	SNVT_count_f
Active DHW Setpoint	R	AI	10	AI	10	nvoActDHW_SP_XXX	SNVT_temp_p
LL Master Setpoint Source	R	AI	11	AI	11	nvoLLMstSPSr_XXX	SNVT_count_f
Active LL Setpoint	R	AI	12	AI	12	nvoAct_LL_SP_XXX	SNVT_temp_p
Supply Sensor	R	AI	13	AI	13	nvoSupSensor_XXX	SNVT_temp_p
Return Sensor	R	AI	14	AI	14	nvoRetSensor_XXX	SNVT_temp_p
Header Sensor	R	AI	15	AI	15	nvoHdrSensor_XXX	SNVT_temp_p
Stack Sensor	R	AI	16	AI	16	nvoStkSensor_XXX	SNVT_temp_p
Outdoor Sensor	R	AI	17	AI	17	nvoOtdrSensr_XXX	SNVT_temp_p
4-20 mA Rem Control Input	R	AI	18	AI	18	nvoRemCtrlIn_XXX	SNVT_count_f
Fan Speed	R	AI	19	AI	19	nvoFan_Speed_XXX	SNVT_count_f
Flame Signal	R	AI	20	AI	20	nvoFlmSig_XXX	SNVT_count_f
Burner Control State	R	AI	21	AI	21	nvoBrnCtrlSt_XXX	SNVT_count_f
Lockout Code	R	AI	22	AI	22	nvoLockotCod_XXX	SNVT_count_f
Hold Code	R	AI	23	AI	23	nvoHoldCode_XXX	SNVT_count_f
Burner Cycle Count	R/W	AV	24	AO	24	nvi/nvoBrnCycCnt_XXX	SNVT_count_f
Burner Run Time	R/W	AV	25	AO	25	nvi/nvoBrnRunTim_XXX	SNVT_time_hour
System Pum Cycle Count	R/W	AV	26	AO	26	nvi/nvoSysPmCyCt_XXX	SNVT_count_f
DHW Pump Cycle Count	R/W	AV	27	AO	27	nvi/nvoDHWpMcyCt_XXX	SNVT_count_f
Boiler Pump Cycle Count	R/W	AV	28	AO	28	nvi/nvoBlrPmCyCt_XXX	SNVT_count_f
CH Modbus Stat	W	BV	29	DO	29	nvi/nvoCHModStat_XXX	SNVT_switch
LLCH Modbus Stat	W	BV	30	DO	30	nvi/nvoLLCHModSt_XXX	SNVT_switch
CH Modbus SP	W	AV	31	AO	31	nvi/nvoCHModSP_XXX	SNVT_temp_p
CH Sequencer Modbus SP	W	AV	32	AO	32	nvi/nvoCHSeqMdSP_XXX	SNVT_temp_p
Outdoor Temperature	W	AV	33	AO	33	nvi/nvoOutTemp_XXX	SNVT_temp_p
CH Modbus Rate	W	AV	34	C	34	nvi/nvoCHModRate_XXX	SNVT_lev_percent
Fan Speed Measured	R	AI	35	AI	35	nvoFanSpdMes_XXX	SNVT_count_f
Modbus command timeout	R/W	AV	36	AO	36	nvoModCmdTim_XXX	SNVT_count_f
CH pump status	R	AI	37	AI	37	nvoCHPmpStat_XXX	SNVT_count_f
DHW pump status	R	AI	38	AI	38	nvoDHWpmpSt_XXX	SNVT_count_f
Boiler pump status	R	AI	39	AI	39	nvoBlrPmpSt_XXX	SNVT_count_f
Low Temp SP	R	AI	40	AI	40	nvoLoTmpSP_XXX	SNVT_temp_p
Low TempSP source	R	AI	41	AI	41	nvoLoTmpSPSr_XXX	SNVT_count_f
Active Low Temp SP	R	AI	42	AI	42	nvoActLoTpSP_XXX	SNVT_temp_p
CH heat demand	W	BI	43	DI	43	nvoCH_HtDem_XXX	SNVT_switch
DHW heat demand	R	BI	44	DI	44	nvoDHW_HtDem_XXX	SNVT_switch
Low Temp Loop demand	R	BI	45	DI	45	nvoLoTpLHtDm_XXX	SNVT_switch

Modbus Points

Modbus Register	Protocol Name	Description	Read/Write
Enable / Disable			
400,577	CH Modbus Stat	CH Modbus STAT 0 = no demand 1 = demand When this register is not written every "Modbus Command Time Out" parameter seconds (default 30 seconds), CH Modbus Stat is reverted to 0, no demand.	W
400,563	LLCH Modbus Stat	LL CH Modbus STAT 0 = no demand 1 = demand When this register is not written every "Modbus Command Time Out" parameter seconds (default 30 seconds), CH Modbus Stat is reverted to 0, no demand.	W
400,203	Burner on/off	Enable / disable burner. 1 = on 0 = off	R
400,006	Demand source	0 = Unknown 1 = No source demand 2 = Central heat 3 = Domestic hot water 4 = Lead Lag slave 5 = Lead Lag master 6 = Central heat frost protection 7 = Domestic hot water frost protection 8 = No demand due to burner switch turned off 9 = Domestic hot water storage 11 = Warm weather shutdown	R
400,066	CH heat demand	0=Off, 1=On	R
400,083	DHW heat demand	0=Off, 1=On	R
400,123	Low Temperature Loop heat demand	0=Off, 1=On	R
Setpoints			
410,579	CH Modbus Setpoint	Use this register to change the boiler setpoint. When this register is not written every "Modbus Command Time Out" parameter seconds (default 30 seconds), setpoint reverts to local setpoint valid range 60 F to 190 F	W
410,562	CH Sequencer Modbus Setpoint	Use this register to change the multiple boiler Sequencer setpoint. When this register is not written every "Modbus Command Time Out" parameter seconds (default 30 seconds), setpoint reverts to local setpoint valid range 60 F to 190 F	W
410,211	CH setpoint	Status of local setpoint	R
410,453	DHW setpoint	Status of local setpoint	R
410,546	Lead Lag setpoint	Status of local setpoint	R
410,212	CH TOD setpoint	Status of local setpoint	R

Modbus Register	Protocol Name	Description	Read/Write
410,065	CH setpoint source	0=Unknown, 1=Normal setpoint, 2=TOD setpoint, 3=Outdoor reset, 4=Remote control (4-20mA), 7=Outdoor reset time of day	R
410,016	Active CH setpoint	-40 F (-40°C) to 266 F (130°C) Setpoint determined by CH setpoint source (register 65).	R
410,081	DHW setpoint source	0=Unknown, 1=Normal setpoint, 2=TOD setpoint, 5=DHW tap setpoint, 6=DHW preheat setpoint	R
410,017	Active DHW setpoint	-40 F (-40°C) to 266 F (130°C) Setpoint determined by DHW setpoint source (register 81).	R
410,162	Lead Lag master setpoint source	0=Unknown, 1=CH setpoint, 2=CH TOD setpoint, 3=Outdoor reset, 4=Remote control (4-20mA), 5=DHW setpoint, 6=DHW TOD setpoint, 7=Outdoor reset time of day, 8=Mix setpoint	R
410,018	Active LL setpoint	-40 F (-40°C) to 266 F (130°C) Setpoint determined by LL setpoint source (register 162).	R
410,643	Low Temperature setpoint	Setpoint entered on the local user interface. valid range 79 F (26.1 C) to 191 F (88.3 C)	R
410,121	Low Temperature setpoint source	0=Unknown, 1=Normal setpoint, 2=TOD setpoint, 3=Outdoor reset, 4=Remote control, 7=Outdoor reset time of day, 9=Outdoor boost	R
410,024	Active Low Temperature setpoint	-40 F (-40°C) to 266 F (130°C) Setpoint determined by Low Temp setpoint source (register 121).	R
Temperature Sensors			
410,007	Supply sensor	-40 F (-40°C) to 266 F (130°C)	R
410,011	Return sensor	-40 F (-40°C) to 266 F (130°C)	R
410,013	Header sensor	-40 F (-40°C) to 266 F (130°C)	R
410,014	Stack sensor	-40 F (-40°C) to 266 F (130°C)	R
410,170	Outdoor sensor	-40 F (-40°C) to 266 F (130°C)	R
400,015	4 - 20 mA remote control input	mA value for S2 (J8-6) parameter selectable as (remote set point) & (remote modulation)	R

Modbus Register	Protocol Name	Description	Read/Write
410,817	Outdoor Temperature	Building Automation may send the controller the outdoor air temperature. Use this register to change the outdoor temperature. When this register is not written every "Modbus Command Time Out" parameter seconds (default 30 seconds), temperature is set to bad data quality and outdoor air reset is set back to local setpoint. valid range -40 F to 302 F	W
Burner			
400,581	CH Modbus Rate	Use this register to drive individual boiler firing rates. This register is used when firing rate control is performed by an external building automation system. Firing rate reverts to local control when register is not written every "Modbus Command Time Out" parameter seconds (default 30 seconds), Range is 0 to 200 % provides 0-100% firing rate.	W
400,008	Fan Speed Measured	Speed of the combustion air blower in rpm	R
400,009	Fan Speed Commanded	Speed of the combustion air blower in rpm	R
400,010	Flame signal	0.01V or 0.01µA precision (0.00-50.00V)	R
400,033	Burner control state	<ul style="list-style-type: none"> 0 Initiate 1 Standby Delay 2 Standby 3 Safe Startup 4 Prepurge - Drive to Purge Rate 5 Prepurge – Measured Purge Time 6 Prepurge – Drive to Lightoff Rate 7 Preignition Test 8 Preignition Time 9 Pilot Flame Establishing Period 10 Main Flame Establishing Period 11 Direct Burner Ignition 12 Run 13 Postpurge 14 Lockout 	R
Trouble Shooting			
410,034	Lockout code	<ul style="list-style-type: none"> Reasons for burner lockout 0 No lockout 3 Burner Interlock Open (ILK OFF) 4 Supply high limit 5 DHW high limit 6 Stack High limit 12 Flame detected out of sequence 14 Delta T Inlet/Outlet High 15 Return Temp Higher Than Supply 16 Supply Temp Rose Too Quickly 18 Lightoff rate proving failed 19 Purge rate proving failed 20 Invalid Safety Parameters 21 Invalid Modulation Parameter 22 Safety data verification needed 23 24VAC voltage low/high 24 Fuel Valve Error 25 Hardware Fault 26 Internal Fault 27 Ignition Failure 31 Fan Failed 32 ILK ON 42 AC Phase Fault 46 Pilot Test Flame 47 Flame Lost 284 Memory Reset 	R

Modbus Register	Protocol Name	Description	Read/Write
410,040	Hold code	Reason for burner hold 0 None 1 Anti short cycle 2 Boiler Safety Limit Open 3 Boiler Safety Limit Open, (ILK Off) 7 Return sensor fault 8 Supply sensor fault 9 DHW sensor fault 10 Stack sensor fault 11 Ignition failure 13 Flame rod shorted to ground 14 Delta T inlet/outlet high 15 Return temp higher than supply 16 Supply temp has risen too quickly 17 Fan speed not proved 23 24VAC voltage low/high 25 Hardware Fault 27 Ignition Failure	R
Statistics			
400,763	Modbus command timeout	This parameter sets the amount of time the control will wait for input from the Energy Management System (EMS). If the EMS does not write to the following register within the "Modbus Command timeout" seconds the following inputs are considered invalid: CH Modbus Stat, CH Modbus Setpoint, CH Sequencer Modbus Setpoint CH Modbus Rate range 30 – 120, Default 30 seconds Other R/W registers should only be written when a value is needed to be changed. Only the above listed registers are stored in non-volatile registers.	R/W
Pump Status			
400,096	CH pump status	See table 1	R
400,100	DHW pump status	See table 1	R
400,108	Boiler pump status	See table 1	R
400,128-400,129	Burner cycle count	0-999,999 (U32)	R/W
400,130-400,131	Burner run time	Hours (U32)	R/W
400,132-400,133	System pump cycle count	0-999,999 (U32)	R/W
400,134-400,135	DHW pump cycle count	0-999,999 (U32)	R/W
400,138-400,139	Boiler pump cycle count	0-999,999 (U32)	R/W

Status	Description	Note
92	Forced On from manual pump control	
93	Forced On due to Outlet high limit is active	
94	Forced On from burner demand	
95	Forced On due to Lead Lag slave has demand	
96	Forced Off from local DHW priority service	
97	Forced Off from Lead Lag DHW priority service	
98	Forced Off from Central Heat anti-condensation	
99	Forced Off from DHW anti-condensation	
100	Forced Off due to DHW high limit is active	
101	Forced Off from EnviraCOM DHW priority service	
102	On due to local CH frost protection is active	
103	On due to Lead Lag CH frost protection is active	
104	On due to local DHW frost protection is active	
105	On due to Lead Lag DHW frost protection is active	
106	On from local Central Heat demand	
107	On from Lead Lag Central Heat demand	
108	On from local DHW demand	
109	On from Lead Lag DHW demand	
110	On from local Mix demand	
111	On from Lead Lag Mix demand	
112	On from local Central Heat service	
113	On from Lead Lag Central Heat service	
114	On from local DHW service	
115	On from Lead Lag DHW service	
116	On from local Mix service	
117	On from Lead Lag Mix service	
118	On from Lead Lag auxiliary pump X	
119	On from Lead Lag auxiliary pump Y	
120	On from Lead Lag auxiliary pump Z	
121	On, but inhibited by pump start delay	
122	On from pump override	
123	Off, not needed	
124	On from burner demand	
125	On from exercise	
126	On from local Lead Lag service	
127	On from local Lead Lag pump demand	

Pump Status Codes

Appendix D. "A" Bank DIP Switch Settings

Address	A0	A1	A2	A3	A4	A5	A6	A7
1	On	Off	Off	Off	Off	Off	Off	Off
2	Off	On	Off	Off	Off	Off	Off	Off
3	On	On	Off	Off	Off	Off	Off	Off
4	Off	Off	On	Off	Off	Off	Off	Off
5	On	Off	On	Off	Off	Off	Off	Off
6	Off	On	On	Off	Off	Off	Off	Off
7	On	On	On	Off	Off	Off	Off	Off
8	Off	Off	Off	On	Off	Off	Off	Off
9	On	Off	Off	On	Off	Off	Off	Off
10	Off	On	Off	On	Off	Off	Off	Off
11	On	On	Off	On	Off	Off	Off	Off
12	Off	Off	On	On	Off	Off	Off	Off
13	On	Off	On	On	Off	Off	Off	Off
14	Off	On	On	On	Off	Off	Off	Off
15	On	On	On	On	Off	Off	Off	Off
16	Off	Off	Off	Off	On	Off	Off	Off
17	On	Off	Off	Off	On	Off	Off	Off
18	Off	On	Off	Off	On	Off	Off	Off
19	On	On	Off	Off	On	Off	Off	Off
20	Off	Off	On	Off	On	Off	Off	Off
21	On	Off	On	Off	On	Off	Off	Off
22	Off	On	On	Off	On	Off	Off	Off
23	On	On	On	Off	On	Off	Off	Off
24	Off	Off	Off	On	On	Off	Off	Off
25	On	Off	Off	On	On	Off	Off	Off
26	Off	On	Off	On	On	Off	Off	Off
27	On	On	Off	On	On	Off	Off	Off
28	Off	Off	On	On	On	Off	Off	Off
29	On	Off	On	On	On	Off	Off	Off
30	Off	On	On	On	On	Off	Off	Off
31	On	On	On	On	On	Off	Off	Off
32	Off	Off	Off	Off	Off	On	Off	Off
33	On	Off	Off	Off	Off	On	Off	Off
34	Off	On	Off	Off	Off	On	Off	Off
35	On	On	Off	Off	Off	On	Off	Off
36	Off	Off	On	Off	Off	On	Off	Off
37	On	Off	On	Off	Off	On	Off	Off
38	Off	On	On	Off	Off	On	Off	Off
39	On	On	On	Off	Off	On	Off	Off
40	Off	Off	Off	On	Off	On	Off	Off
41	On	Off	Off	On	Off	On	Off	Off
42	Off	On	Off	On	Off	On	Off	Off
43	On	On	Off	On	Off	On	Off	Off
44	Off	Off	On	On	Off	On	Off	Off
45	On	Off	On	On	Off	On	Off	Off
46	Off	On	On	On	Off	On	Off	Off
47	On	On	On	On	Off	On	Off	Off
48	Off	Off	Off	Off	On	On	Off	Off

Address	A0	A1	A2	A3	A4	A5	A6	A7
49	On	Off	Off	Off	On	On	Off	Off
50	Off	On	Off	Off	On	On	Off	Off
51	On	On	Off	Off	On	On	Off	Off
52	Off	Off	On	Off	On	On	Off	Off
53	On	Off	On	Off	On	On	Off	Off
54	Off	On	On	Off	On	On	Off	Off
55	On	On	On	Off	On	On	Off	Off
56	Off	Off	Off	On	On	On	Off	Off
57	On	Off	Off	On	On	On	Off	Off
58	Off	On	Off	On	On	On	Off	Off
59	On	On	Off	On	On	On	Off	Off
60	Off	Off	On	On	On	On	Off	Off
61	On	Off	On	On	On	On	Off	Off
62	Off	On	On	On	On	On	Off	Off
63	On	On	On	On	On	On	Off	Off
64	Off	Off	Off	Off	Off	Off	On	Off
65	On	Off	Off	Off	Off	Off	On	Off
66	Off	On	Off	Off	Off	Off	On	Off
67	On	On	Off	Off	Off	Off	On	Off
68	Off	Off	On	Off	Off	Off	On	Off
69	On	Off	On	Off	Off	Off	On	Off
70	Off	On	On	Off	Off	Off	On	Off
71	On	On	On	Off	Off	Off	On	Off
72	Off	Off	Off	On	Off	Off	On	Off
73	On	Off	Off	On	Off	Off	On	Off
74	Off	On	Off	On	Off	Off	On	Off
75	On	On	Off	On	Off	Off	On	Off
76	Off	Off	On	On	Off	Off	On	Off
77	On	Off	On	On	Off	Off	On	Off
78	Off	On	On	On	Off	Off	On	Off
79	On	On	On	On	Off	Off	On	Off
80	Off	Off	Off	Off	On	Off	On	Off
81	On	Off	Off	Off	On	Off	On	Off
82	Off	On	Off	Off	On	Off	On	Off
83	On	On	Off	Off	On	Off	On	Off
84	Off	Off	On	Off	On	Off	On	Off
85	On	Off	On	Off	On	Off	On	Off
86	Off	On	On	Off	On	Off	On	Off
87	On	On	On	Off	On	Off	On	Off
88	Off	Off	Off	On	On	Off	On	Off
89	On	Off	Off	On	On	Off	On	Off
90	Off	On	Off	On	On	Off	On	Off
91	On	On	Off	On	On	Off	On	Off
92	Off	Off	On	On	On	Off	On	Off
93	On	Off	On	On	On	Off	On	Off
94	Off	On	On	On	On	Off	On	Off
95	On	On	On	On	On	Off	On	Off
96	Off	Off	Off	Off	Off	On	On	Off

Address	A0	A1	A2	A3	A4	A5	A6	A7
97	On	Off	Off	Off	Off	On	On	Off
98	Off	On	Off	Off	Off	On	On	Off
99	On	On	Off	Off	Off	On	On	Off
100	Off	Off	On	Off	Off	On	On	Off
101	On	Off	On	Off	Off	On	On	Off
102	Off	On	On	Off	Off	On	On	Off
103	On	On	On	Off	Off	On	On	Off
104	Off	Off	Off	On	Off	On	On	Off
105	On	Off	Off	On	Off	On	On	Off
106	Off	On	Off	On	Off	On	On	Off
107	On	On	Off	On	Off	On	On	Off
108	Off	Off	On	On	Off	On	On	Off
109	On	Off	On	On	Off	On	On	Off
110	Off	On	On	On	Off	On	On	Off
111	On	On	On	On	Off	On	On	Off
112	Off	Off	Off	Off	On	On	On	Off
113	On	Off	Off	Off	On	On	On	Off
114	Off	On	Off	Off	On	On	On	Off
115	On	On	Off	Off	On	On	On	Off
116	Off	Off	On	Off	On	On	On	Off
117	On	Off	On	Off	On	On	On	Off
118	Off	On	On	Off	On	On	On	Off
119	On	On	On	Off	On	On	On	Off
120	Off	Off	Off	On	On	On	On	Off
121	On	Off	Off	On	On	On	On	Off
122	Off	On	Off	On	On	On	On	Off
123	On	On	Off	On	On	On	On	Off
124	Off	Off	On	On	On	On	On	Off
125	On	Off	On	On	On	On	On	Off
126	Off	On	On	On	On	On	On	Off
127	On	On	On	On	On	On	On	Off
128	Off	Off	Off	Off	Off	Off	Off	On
129	On	Off	Off	Off	Off	Off	Off	On
130	Off	On	Off	Off	Off	Off	Off	On
131	On	On	Off	Off	Off	Off	Off	On
132	Off	Off	On	Off	Off	Off	Off	On
133	On	Off	On	Off	Off	Off	Off	On
134	Off	On	On	Off	Off	Off	Off	On
135	On	On	On	Off	Off	Off	Off	On
136	Off	Off	Off	On	Off	Off	Off	On
137	On	Off	Off	On	Off	Off	Off	On
138	Off	On	Off	On	Off	Off	Off	On
139	On	On	Off	On	Off	Off	Off	On
140	Off	Off	On	On	Off	Off	Off	On
141	On	Off	On	On	Off	Off	Off	On
142	Off	On	On	On	Off	Off	Off	On
143	On	On	On	On	Off	Off	Off	On
144	Off	Off	Off	Off	On	Off	Off	On
145	On	Off	Off	Off	On	Off	Off	On

Address	A0	A1	A2	A3	A4	A5	A6	A7
146	Off	On	Off	Off	On	Off	Off	On
147	On	On	Off	Off	On	Off	Off	On
148	Off	Off	On	Off	On	Off	Off	On
149	On	Off	On	Off	On	Off	Off	On
150	Off	On	On	Off	On	Off	Off	On
151	On	On	On	Off	On	Off	Off	On
152	Off	Off	Off	On	On	Off	Off	On
153	On	Off	Off	On	On	Off	Off	On
154	Off	On	Off	On	On	Off	Off	On
155	On	On	Off	On	On	Off	Off	On
156	Off	Off	On	On	On	Off	Off	On
157	On	Off	On	On	On	Off	Off	On
158	Off	On	On	On	On	Off	Off	On
159	On	On	On	On	On	Off	Off	On
160	Off	Off	Off	Off	Off	On	Off	On
161	On	Off	Off	Off	Off	On	Off	On
162	Off	On	Off	Off	Off	On	Off	On
163	On	On	Off	Off	Off	On	Off	On
164	Off	Off	On	Off	Off	On	Off	On
165	On	Off	On	Off	Off	On	Off	On
166	Off	On	On	Off	Off	On	Off	On
167	On	On	On	Off	Off	On	Off	On
168	Off	Off	Off	On	Off	On	Off	On
169	On	Off	Off	On	Off	On	Off	On
170	Off	On	Off	On	Off	On	Off	On
171	On	On	Off	On	Off	On	Off	On
172	Off	Off	On	On	Off	On	Off	On
173	On	Off	On	On	Off	On	Off	On
174	Off	On	On	On	Off	On	Off	On
175	On	On	On	On	Off	On	Off	On
176	Off	Off	Off	Off	On	On	Off	On
177	On	Off	Off	Off	On	On	Off	On
178	Off	On	Off	Off	On	On	Off	On
179	On	On	Off	Off	On	On	Off	On
180	Off	Off	On	Off	On	On	Off	On
181	On	Off	On	Off	On	On	Off	On
182	Off	On	On	Off	On	On	Off	On
183	On	On	On	Off	On	On	Off	On
184	Off	Off	Off	On	On	On	Off	On
185	On	Off	Off	On	On	On	Off	On
186	Off	On	Off	On	On	On	Off	On
187	On	On	Off	On	On	On	Off	On
188	Off	Off	On	On	On	On	Off	On
189	On	Off	On	On	On	On	Off	On
190	Off	On	On	On	On	On	Off	On
191	On	On	On	On	On	On	Off	On
192	Off	Off	Off	Off	Off	Off	On	On
193	On	Off	Off	Off	Off	Off	On	On
194	Off	On	Off	Off	Off	Off	On	On

Address	A0	A1	A2	A3	A4	A5	A6	A7
195	On	On	Off	Off	Off	Off	On	On
196	Off	Off	On	Off	Off	Off	On	On
197	On	Off	On	Off	Off	Off	On	On
198	Off	On	On	Off	Off	Off	On	On
199	On	On	On	Off	Off	Off	On	On
200	Off	Off	Off	On	Off	Off	On	On
201	On	Off	Off	On	Off	Off	On	On
202	Off	On	Off	On	Off	Off	On	On
203	On	On	Off	On	Off	Off	On	On
204	Off	Off	On	On	Off	Off	On	On
205	On	Off	On	On	Off	Off	On	On
206	Off	On	On	On	Off	Off	On	On
207	On	On	On	On	Off	Off	On	On
208	Off	Off	Off	Off	On	Off	On	On
209	On	Off	Off	Off	On	Off	On	On
210	Off	On	Off	Off	On	Off	On	On
211	On	On	Off	Off	On	Off	On	On
212	Off	Off	On	Off	On	Off	On	On
213	On	Off	On	Off	On	Off	On	On
214	Off	On	On	Off	On	Off	On	On
215	On	On	On	Off	On	Off	On	On
216	Off	Off	Off	On	On	Off	On	On
217	On	Off	Off	On	On	Off	On	On
218	Off	On	Off	On	On	Off	On	On
219	On	On	Off	On	On	Off	On	On
220	Off	Off	On	On	On	Off	On	On
221	On	Off	On	On	On	Off	On	On
222	Off	On	On	On	On	Off	On	On
223	On	On	On	On	On	Off	On	On
224	Off	Off	Off	Off	Off	On	On	On
225	On	Off	Off	Off	Off	On	On	On
226	Off	On	Off	Off	Off	On	On	On
227	On	On	Off	Off	Off	On	On	On
228	Off	Off	On	Off	Off	On	On	On
229	On	Off	On	Off	Off	On	On	On
230	Off	On	On	Off	Off	On	On	On
231	On	On	On	Off	Off	On	On	On
232	Off	Off	Off	On	Off	On	On	On
233	On	Off	Off	On	Off	On	On	On
234	Off	On	Off	On	Off	On	On	On
235	On	On	Off	On	Off	On	On	On
236	Off	Off	On	On	Off	On	On	On
237	On	Off	On	On	Off	On	On	On
238	Off	On	On	On	Off	On	On	On
239	On	On	On	On	Off	On	On	On
240	Off	Off	Off	Off	On	On	On	On
241	On	Off	Off	Off	On	On	On	On
242	Off	On	Off	Off	On	On	On	On
243	On	On	Off	Off	On	On	On	On

Address	A0	A1	A2	A3	A4	A5	A6	A7
244	Off	Off	On	Off	On	On	On	On
245	On	Off	On	Off	On	On	On	On
246	Off	On	On	Off	On	On	On	On
247	On	On	On	Off	On	On	On	On
248	Off	Off	Off	On	On	On	On	On
249	On	Off	Off	On	On	On	On	On
250	Off	On	Off	On	On	On	On	On
251	On	On	Off	On	On	On	On	On
252	Off	Off	On	On	On	On	On	On
253	On	Off	On	On	On	On	On	On
254	Off	On	On	On	On	On	On	On
255	On	On	On	On	On	On	On	On

